

# MASTERLOK-FS MASTERLOK-90

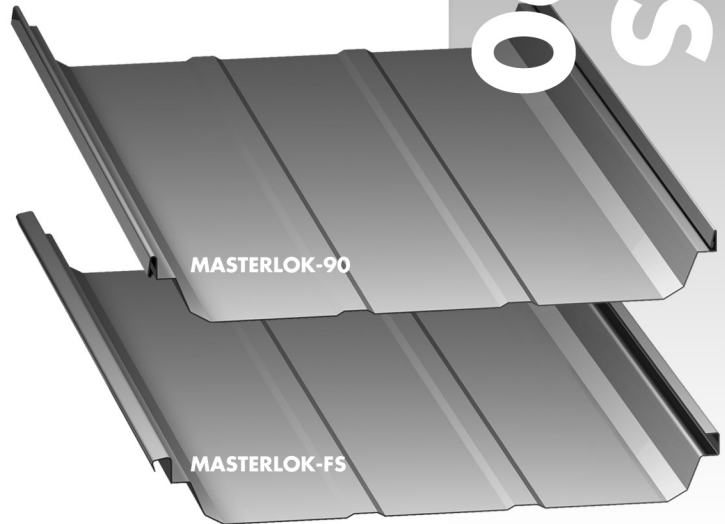

## Panel/Trim /Accessories





# MASTERLOK-90/FS

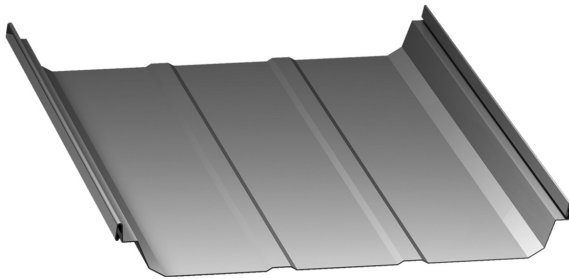

**MasterLok-90**

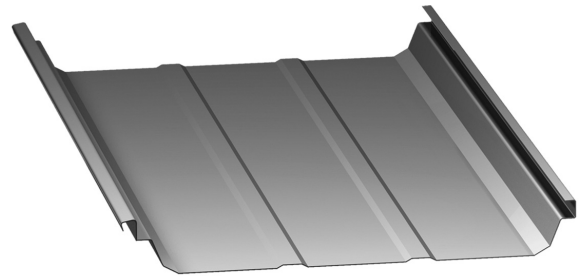

**MasterLok-FS**

MASTERLOK-90 PANEL

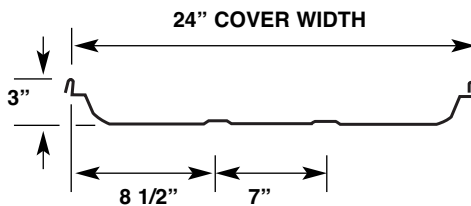

MASTERLOK-FS PANEL

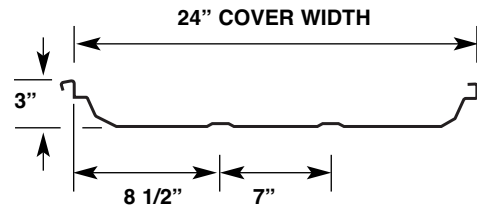

## MasterLok-90 / MasterLok-FS Load Tables and Section Properties

Load tables and section properties for MasterLok-90 and MasterLok-FS can be found online at [www.mcelroymetal.com](http://www.mcelroymetal.com). Please contact the **McElroy Engineering Department at 1-800-950-9082** for additional information.

### Details:

- Factory applied sealant in seam to improve weather-tightness
- Minimum Slope: 1/4:12
- Can be installed over solid deck or open framing
- MasterLok-FS is a mechanically seamed profile
- MasterLok-90 also available with MoistureLok

### Panel Options:

- Panel width: 24"
- Coating:
  - Kynar 500® (PVDF)
- Substrate:
  - Standard 24 GA Galvalume®
  - Optional 22 GA Galvalume

### Notes:

- Oil canning is inherent in all metal panels and is not cause for panel rejection.
- Please contact a McElroy representative for specific pricing, lead times, special colors or gauges that may not be on a McElroy Metal color chart.
- Contents in this manual are subject to change without notice. To confirm this book is the most current copy, please visit McElroy's website at [www.mcelroymetal.com](http://www.mcelroymetal.com).

# MASTERLOK-90/FS

## TRIM

24 GA

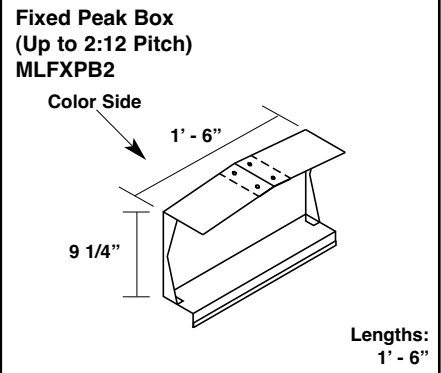
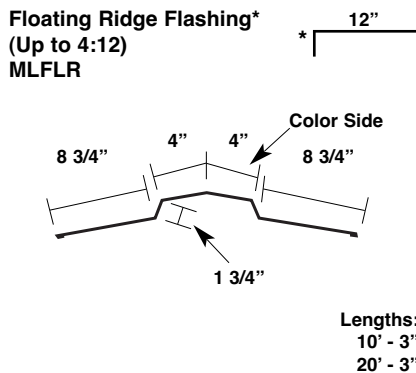
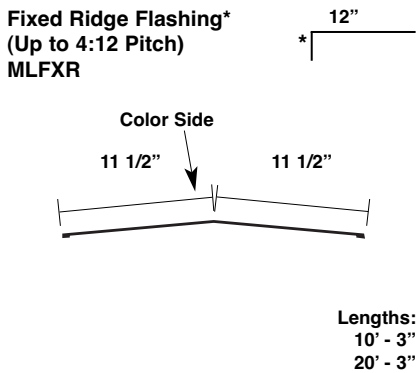
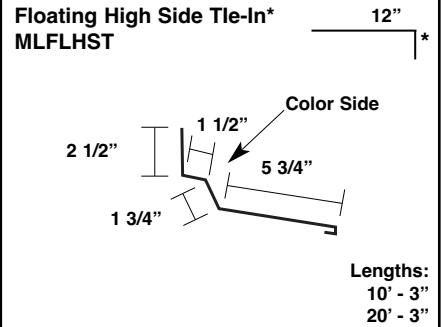
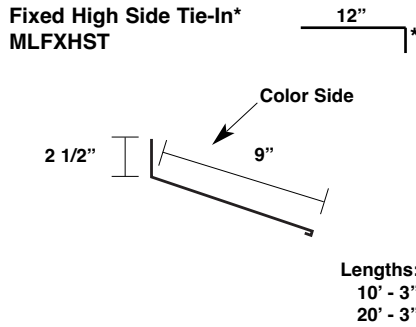
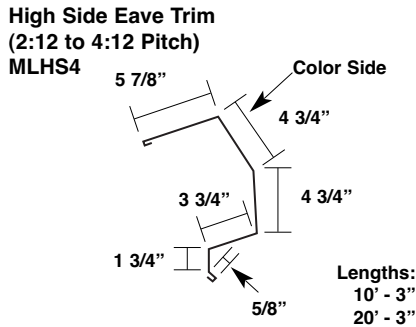
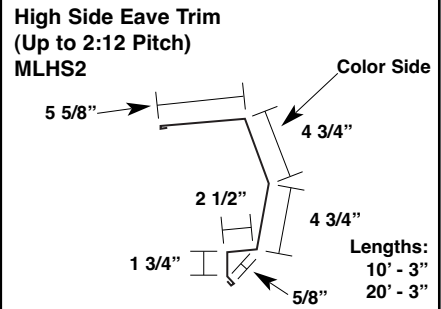
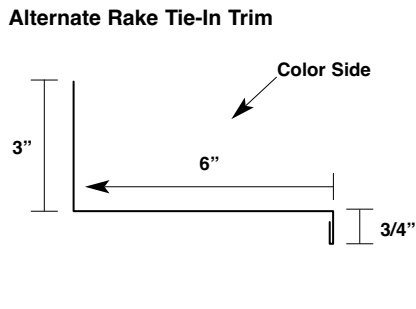
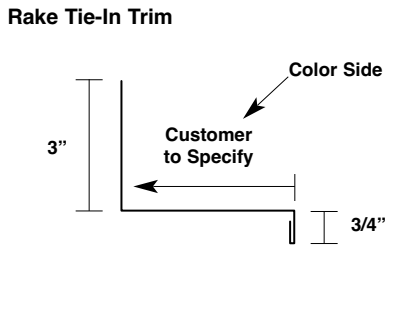
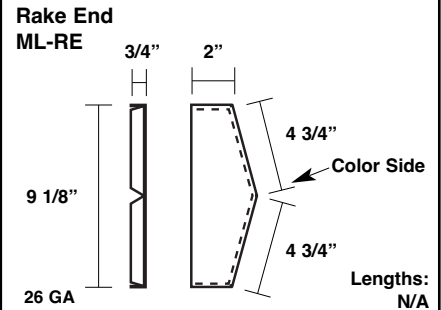
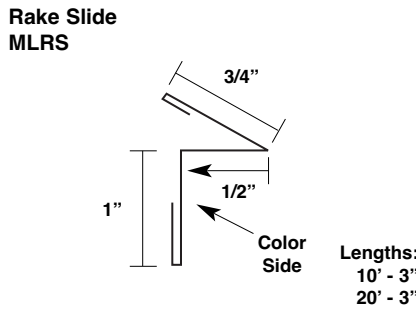
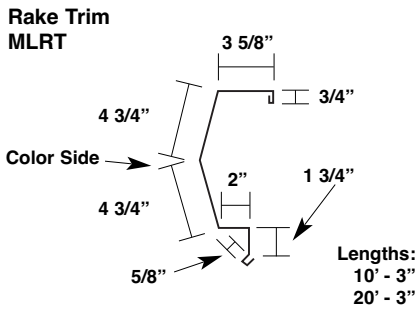
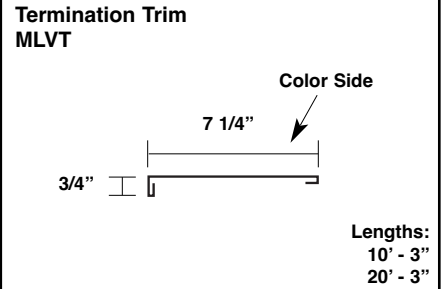
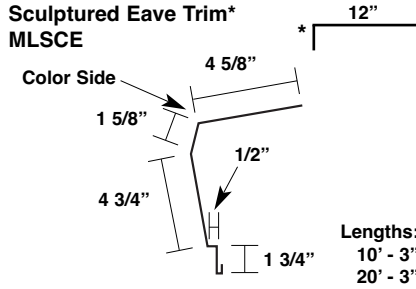
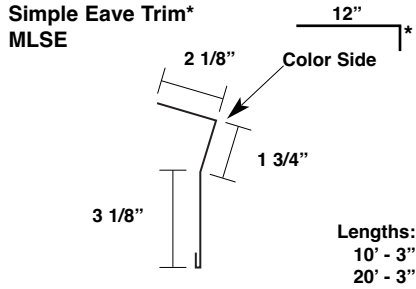

\*specify roof pitch

\* Indicates an open hem - All other hems are closed.

# MASTERLOK-90/FS

## TRIM

24 GA

**Fixed Peak Box**  
(2:12 to 4:12 Pitch)  
MLFXPB4

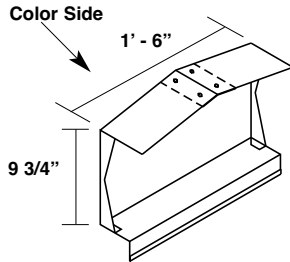

Lengths:  
1' - 6"

**Floating Peak Box**  
(Up to 2:12 Pitch)  
MLFLPB2

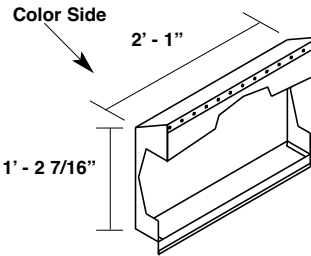

Lengths:  
2' - 1"

**Floating Peak Box**  
(2:12 to 4:12 Pitch)  
MLFLPB4

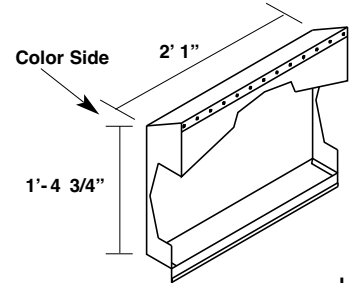

Lengths:  
2' - 1"

**Gutter**  
(Up to 2:12 Pitch)  
MLG2

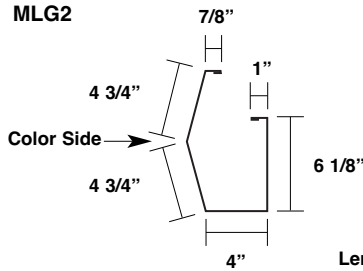

Lengths:  
10' - 3"  
20' - 3"

**Gutter**  
(2:12 to 4:12 Pitch)  
MLG4

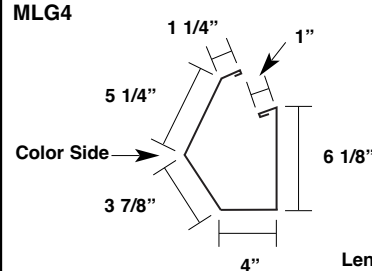

Lengths:  
10' - 3"  
20' - 3"

**Gutter Strap**  
ML-GS

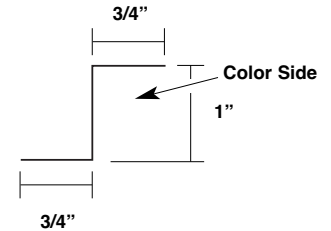

Lengths:  
0' - 6"

**Gutter End Cap**  
(Up to 2:12 Pitch)  
MLGE2

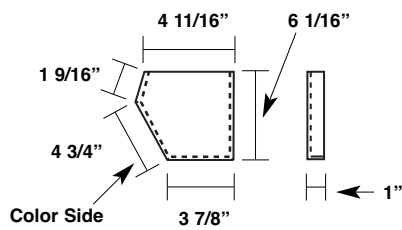

26 GA

Lengths:  
N/A

**Gutter End Cap**  
(2:12 to 4:12 Pitch)  
MLGE4

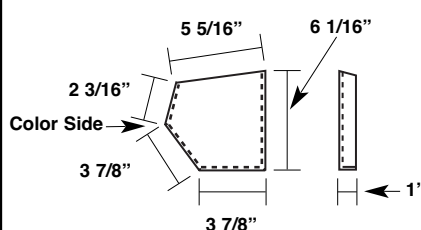

26 GA

Lengths:  
N/A

**Outside Corner Box for Standard Gutter**  
(Up to 2:12 Pitch)  
(Right Hand Shown - Left Hand Opposite)  
MLOCB

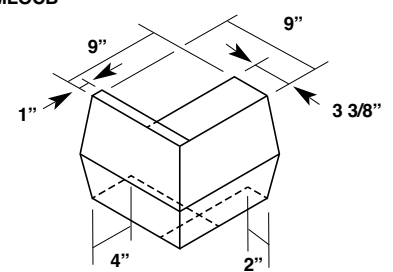

26 GA

Lengths:  
N/A

**Gutter Corner Box for Standard Gutter**  
(2:12 to 4:12 pitch or with Sculptured Gutter)  
(Right Hand Shown-Left Hand Opposite)

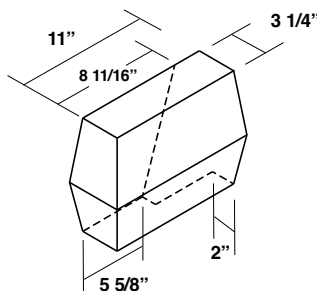

26 GA

Lengths:  
N/A

**Gutter Corner Box for Sculptured Eave**  
(Up to 4:12 Pitch)  
(Right Hand Shown-Left Hand Opposite)

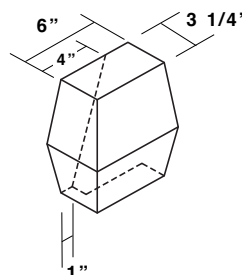

26 GA

Lengths:  
N/A

**High Side Corner Box**  
(Right Hand Shown-Left Hand Opposite)  
MLHCB

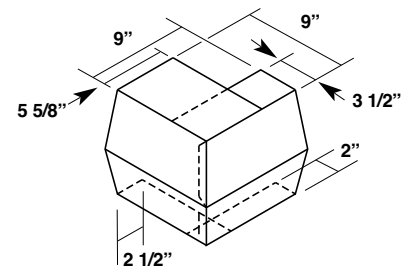

26 GA

Lengths:  
N/A

\*specify roof pitch

\* Indicates an open hem - All other hems are closed.

# MASTERLOK-90/FS

26 GA

**Cinch Angle  
ML-CA**

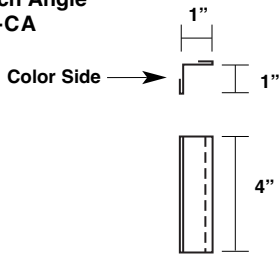

26 Ga.

Lengths:  
0' - 4"

**High-Low Tie-In Trim\*  
MLHL**

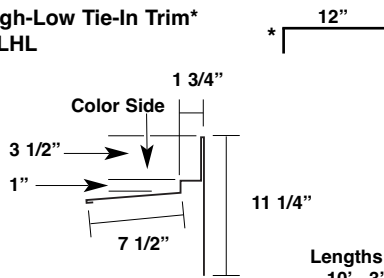

Lengths:  
10' - 3"  
20' - 3"

**Zee Flashing  
ML3ZF**

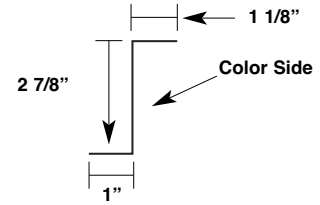

Lengths:  
10' - 3"

**Insulation Angle Trim  
MLIA**

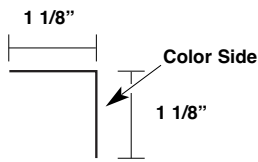

Lengths:  
10' - 3"

**Insulation Zee Trim  
MLIZ**

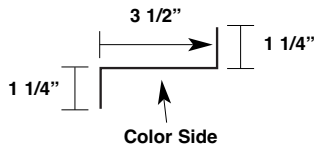

Lengths:  
2' - 0"

**Aluminum Downspout Outlet Box  
BBPOUT**

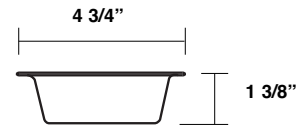

Lengths:  
N/A

**3" x 4" Downspout  
BBPDS**

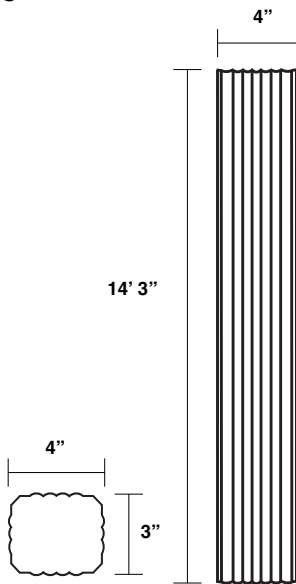

Lengths:  
14' - 3"

**Downspout Strap  
BBPDS**

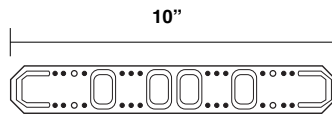

Lengths:  
10"

**3" x 4" Downspout Elbow  
A-Style  
BBPELA**

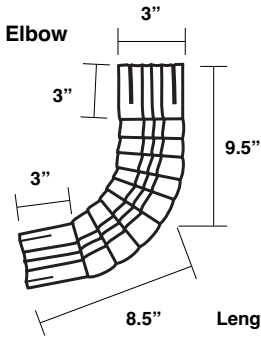

Lengths:  
N/A

**Lock-Seam Downspout - Corner  
(Right Hand Corner Shown)**

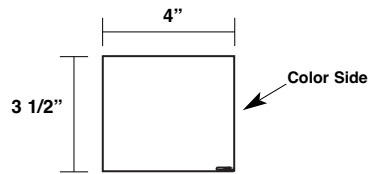

Please specify left or right hand corner

**Lock-Seam Downspout - Center**

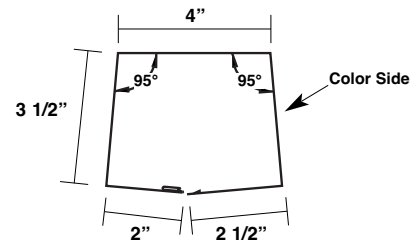

**Lock-Seam Downspout Outlet -  
Standard**

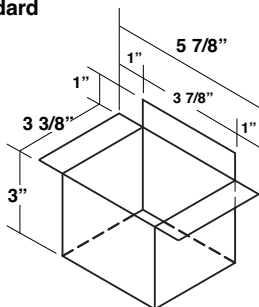

**Lock-Seam Downspout Strap**

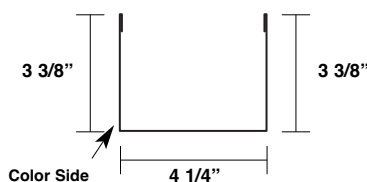

\*specify roof pitch

# MASTERLOK-90/FS

## ACCESSORIES

1/4 - 14 x 1 1/4"

TEK2  
Self Driller  
W/O Washer - Plain  
Item #: 10969

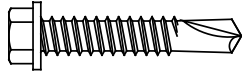

#12 - 24 x 1 1/4"

TEK 4.5  
W/O Washer - Plain  
Item #: 10979

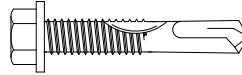

1/4 - 14 x 1 1/4"

Shoulder TEK2 3/8  
HWH W/O Washer - Plain  
Item #: 10975

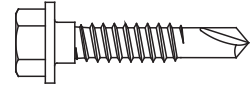

1/4 - 14 x 1 1/4"

TEK2 ZAC  
(Part # varies by color)

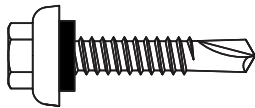

1/4 - 14 x 7/8"

LAPTEK ZAC  
Self Driller  
(Part # varies by color)

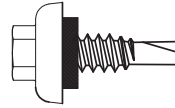

#14-10 Dekfast Pan Head  
(Length varies by application)



43D Pop Rivet  
(Part # varies by color.)



ML-90 Utility Fixed Clip  
Item #: 10919

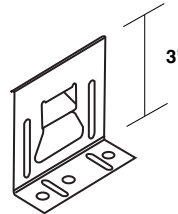

ML-90 Low Fixed Clip  
Item #: 10921

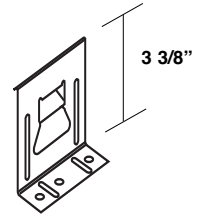

ML-90 High Fixed Clip  
Item #: 10922

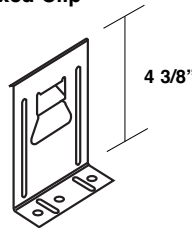

ML-90 Utility Floating Clip  
Item #: 10920

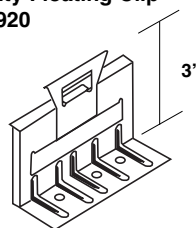

ML-90 Low Floating Clip  
Item #: 10923

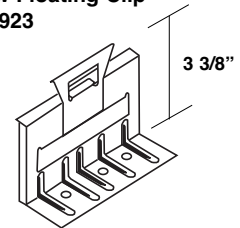

ML-90 High Floating Clip  
Item #: 10924

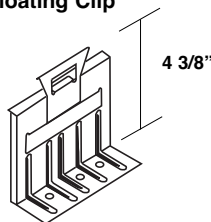

ML-FS Low Floating Clip  
Item #: 10211

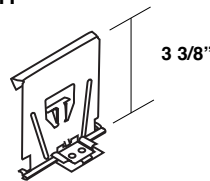

ML-FS High Floating Clip  
Item #: 10212

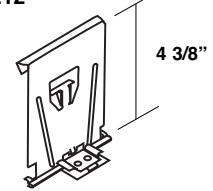

ML-FS 5" Tall Clip  
Item #: 227329

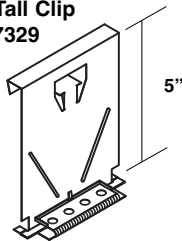

Utility Eave Plate  
Item #: 17477

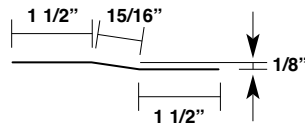

Lengths:  
10'

Low Eave Plate  
Item #: 10936

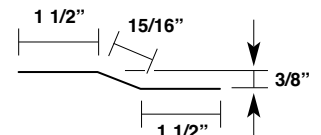

Lengths:  
10'

# MASTERLOK-90/FS

## ACCESSORIES

**Utility Fixed Rake Support Angle**  
Item #: 10' - 11213  
Item #: 20' - 11196

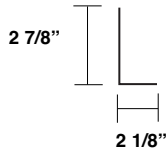

Lengths:  
10'  
20'

**Low Fixed Rake Support Angle**  
Item #: 10' - 11005  
Item #: 20' - 10941

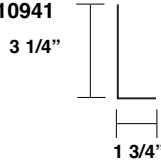

Lengths:  
10'  
20'

**High Fixed Rake Support Angle**  
Item #: 10' - 11002  
Item #: 20' - 10943

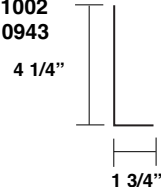

Lengths:  
10'  
20'

**Utility Floating Rake Support Angle**  
Item #: 10942

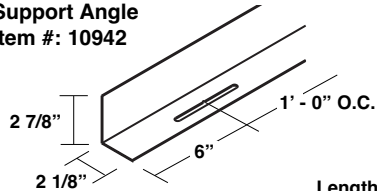

Lengths:  
10'

**Low Floating Rake Support Angle**  
Item #: 10944

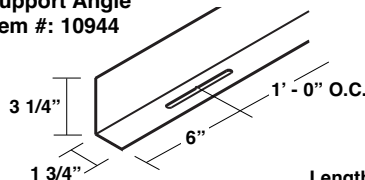

Lengths:  
10'

**High Floating Rake Support Angle**  
Item #: 10946

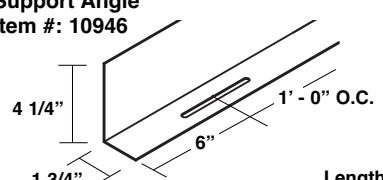

Lengths:  
10'

**MLFS Tall Floating Rake Support Angle**  
Item #: 232319

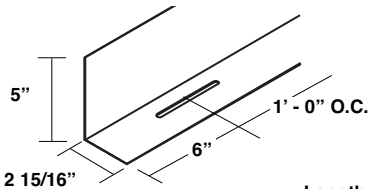

Lengths:  
10'

16 GA

**MLFS Tall Eave Plate**  
Item #: 232237

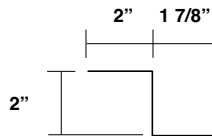

Lengths:  
10'

16 GA

**MLFS Tall Floating Rake Plate**  
Item #: 232318

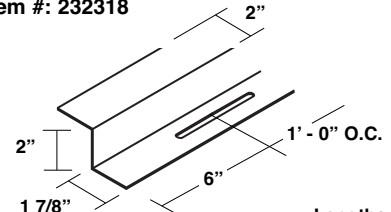

Lengths:  
10'

16 GA

**Floating Eave Plate 2" Stdoff**  
Item #: 232440

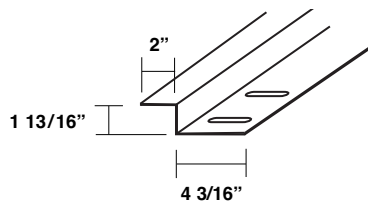

Lengths:  
8'

14 GA

**Bearing Plate**  
Primed Item #: 94599  
Galvanized Item #: 203541

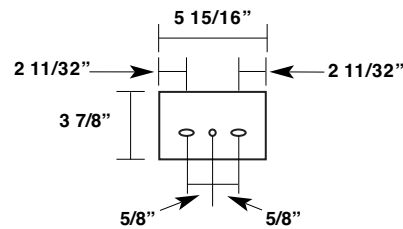

**Modified Back-Up Plate for 18" and 24" Utility Systems**  
Item # 18": 11206  
Item # 24": 10948

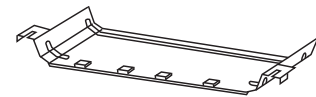

Lengths:  
18"  
24"

**Standard Back-Up Plate for 24" Wide Panels**  
Item #: 10949

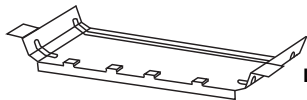

Lengths:  
18"  
24"

**Standard Back-Up Plate for 18" Wide Panels**  
Item #: 10950

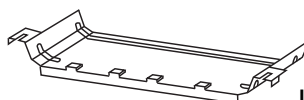

Lengths:  
18"

**Inside Closure - Metal**  
(Part # varies by color)



**Inside Closure - Rubber**  
Item #: 10957



**Outside Closure**  
(Part # varies by color)

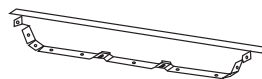

**ML-90 Cinch Strap**  
(Part # varies by color)

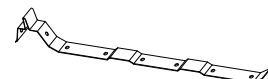



# MASTERLOK-90/FS

## ACCESSORIES

**ML-FS Cinch Strap**  
(Part # varies by color)

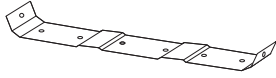

**Butyl Tape Sealant - Double Bead**  
3/16" x 7/8" x 40'  
Item #: 95460

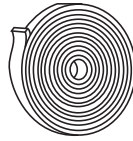

**Butyl Tape Sealant**  
1 1/2" x 1/8" x 30'  
Item #: 10959

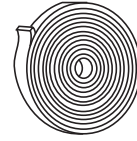

**Butyl Tape Sealant**  
3/32" x 1" x 45'  
Item #: 95335

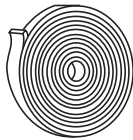

**Strip Tape**  
3/4" x 1 3/8" x 7/32" x 4"  
Item #: 95365

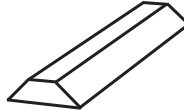

**Titebond Caulk Sealant**  
(Part # varies by color)



**Sikalastomer Butyl Tube Sealant**  
Item #: 95342



**Thermal Spacer**  
3/8" x 3" x 23 7/8" Item #: 11006  
5/8" x 3" x 23 7/8" Item #: 11008  
1" x 3" x 23 7/8" Item #: 10960  
1 3/8" x 3" x 23 7/8" Item #: 10961

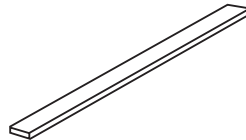

**Touch-Up Paint Pen**  
(Part # Varies by Color)



**ML90 Seam Snapping Tool**  
Item #: 10967

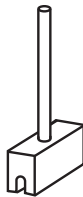

**Unseaming Tool**  
(ML-90 Only)  
Item #: 10966

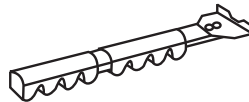

### Notes:

Blank area for notes.



# *MASTERLOK-90/FS*

**NOTES:**



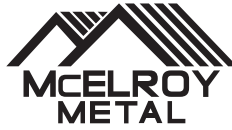

☆ MANUFACTURING LOCATIONS ● SERVICE CENTERS ★ MANUFACTURING AND SERVICE CENTER



**CORPORATE OFFICE**  
1500 HAMILTON RD.  
BOSSIER CITY, LA 71111

**MANUFACTURING LOCATIONS**

ADELANTO, CA	ASHBURN, GA	BOSSIER CITY, LA	CLINTON, IL	DIAMOND, MO
HOUSTON, TX	LEWISPORT, KY	MARSHALL, MI	MAUSTON, WI	MERKEL, TX
	PEACHTREE CITY, GA	SUNNYVALE, TX	WINCHESTER, VA	

**MCELROY METAL**  
**SERVICE**  
C E N T E R

17031 Koala Road Adelanto, CA 92301	5215 Leo St. Alexandria, LA 71301	1007 Wilso Dr, Baltimore, MD 21223	1500 Hamilton Rd. Bossier City, LA 71111
3052 Yadkin Road Chesapeake, VA 23323	9476 Meadowbrook Rd. Clinton, IL 61727	3215 Highway 59 Diamond, MO 64840	390 N. Valley Dell Dr. Fenton, MO 63026
409 Lovejoy Road Ft. Walton Beach, FL 32548	3014 Lincoln Court Garland, TX 75041	1440 Aldine Bender Road Houston, TX 77032	10504 E. 59th Street Indianapolis, IN 46236
9435 US Hwy. 60 W. Lewisport, KY 42351	1020 Veterans Street Mauston, WI 53948	5123 Terminal Dr. McFarland, WI 53558	514 Cave Road Nashville, TN 37210
8304 Hwy. 70 E. North Little Rock, AR 72117	613 North Bierdeman Rd. Pearl, MS 39208	8511 Industrial Drive Pearland, TX 77584	7450 Tower Street Richland Hills, TX 76118
8200 Berry Ave. Suite 100 Sacramento, CA 95828	1144 Silstar Rd. West Columbia, SC 29170	1365 Dean Forest Rd. Savannah, GA 31405	7355 Oakley Industrial Blvd. Union City, GA 30291
		325 McGhee Rd. Winchester, VA 22603	

Website: [www.mcelroymetal.com](http://www.mcelroymetal.com) • E-mail: [info@mcelroymetal.com](mailto:info@mcelroymetal.com)