

MIRAGE II MIRAGE

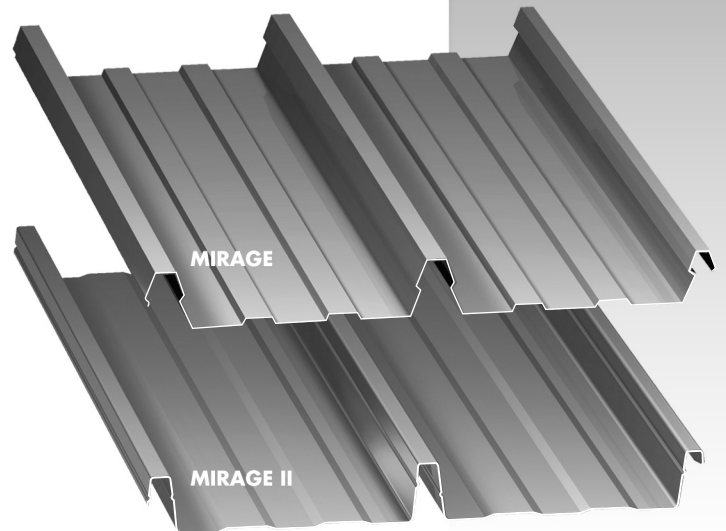

Panel/Trim /Accessories



MIRAGE

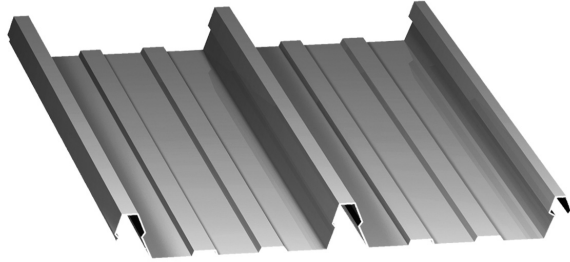

Mirage

Mirage Panel

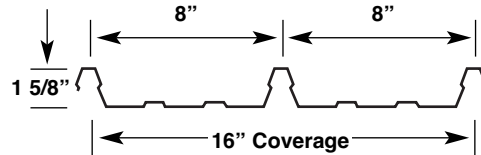

Mirage Test Data. Section Properties or Load Tables

For any available Testing Data, Section Properties, or Load Tables, please visit www.mcelroymetal.com. For all other additional information, please contact the **McElroy Engineering Department at 1-800-950-9082**.

Mirage Seam Detail

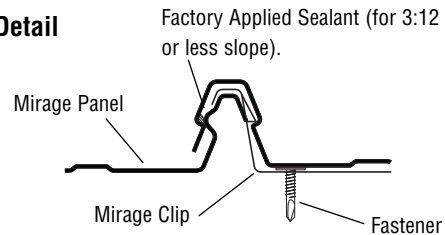

Details:

- Minimum Slope: 1/4:12
- Factory applied sealant is required in seam (side laps) at less than 3:12 slope
- Can be installed over solid deck or open framing
- Mirage is also available with MoistureLok

- Mirage is produced in Adelanto, CA

Panel Options:

- Panel width: 16"
- Panel configurations: ribbed

- Coating:
 - Kynar 500® (PVDF)

- Substrate:
 - Standard 24 GA Galvalume®

Notes:

- Oil canning is a natural occurrence in metal panels and is not cause for panel rejection.
- Please contact a McElroy representative for specific pricing, lead times, special colors or gauges that may not be on a McElroy Metal color chart.
- Contents in this manual are subject to change without notice. To confirm this book is the most current copy, please visit McElroy's website at www.mcelroymetal.com.

MIRAGE

TRIM

26 GA

Simple Eave*
Up to 6:12 Pitch

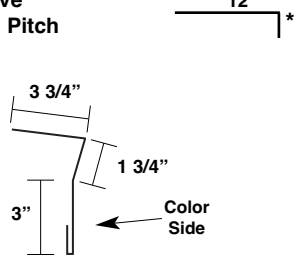

Lengths:
LF

Sculptured Eave*
Up to 6:12 Pitch

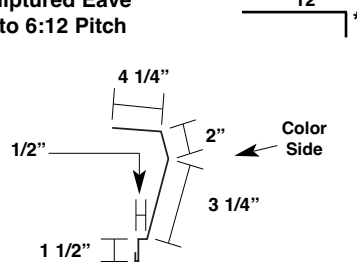

Lengths:
LF

Rake Trim

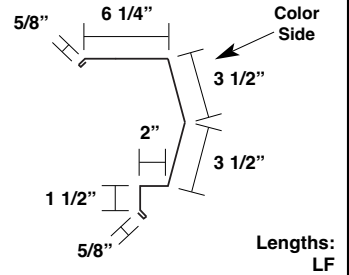

Lengths:
LF

Rake Tie-In

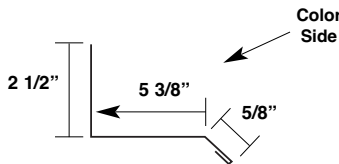

Lengths:
LF

Rake Slide

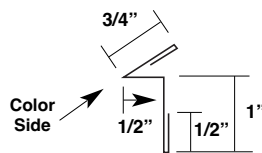

Lengths:
LF

Rake Closure

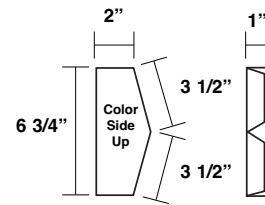

Zee Closure

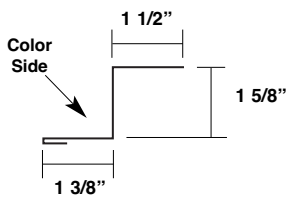

Lengths:
LF

Floating High Side
Tie-In Trim*
Up to 6:12 Pitch

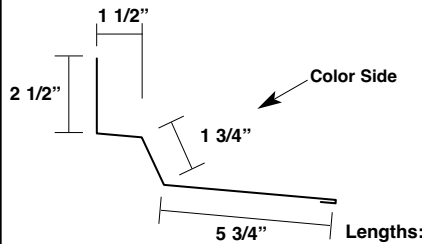

Lengths:
LF

Alternate High Side
Tie-In Trim*
Up to 6:12 Pitch

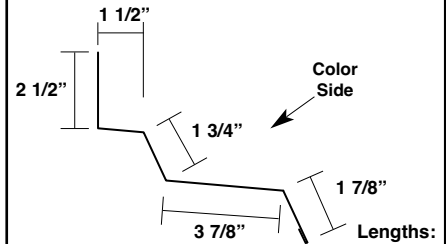

Lengths:
LF

High Side Eave Trim*
Up to 6:12 Pitch

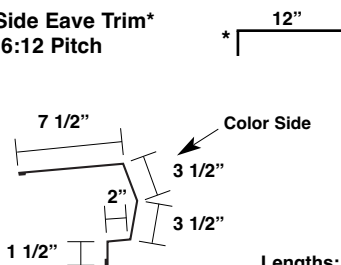

Lengths:
LF

Alternate High Side
Eave Trim*
Up to 6:12 Pitch

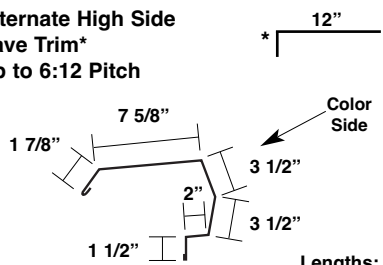

Lengths:
LF

Fixed Ridge Cap*
Up to 6:12 Pitch

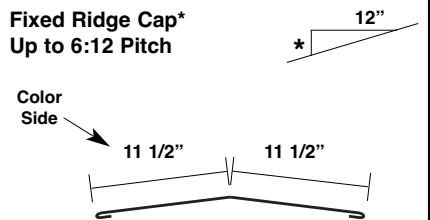

Lengths:
LF

Alternate Fixed Ridge Cap*
Up to 6:12 Pitch

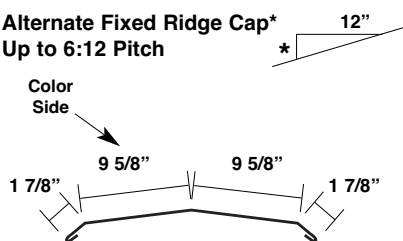

Lengths:
LF

Floating Ridge Cap*
Up to 6:12 Pitch

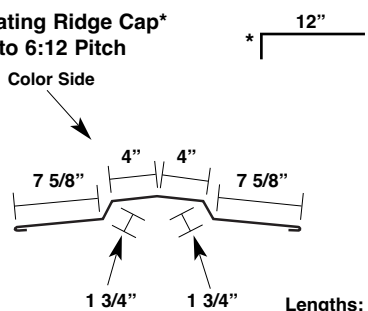

Lengths:
LF

Alternate Floating
Ridge Cap*
Up to 6:12 Pitch

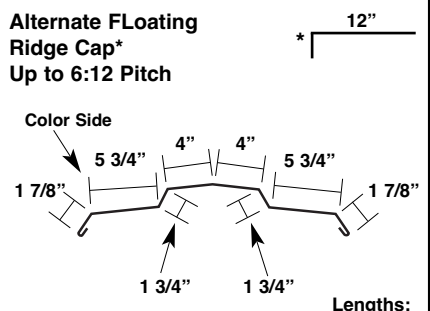

Lengths:
LF

*specify roof pitch

(H) Indicates an open hem - All other hems are closed.

MIRAGE

TRIM

Fixed Peak Box For 3:12
(Additional Roof Pitch Available - 1:12 to 6:12)

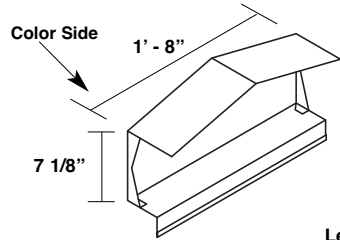

24 GA

Lengths:
1' - 8"

Floating Peak Box For 3:12
(Additional Roof Pitch Available - 1:12 to 6:12)

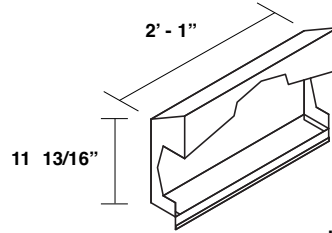

24 GA

Lengths:
2' - 1"

Cinch Angle

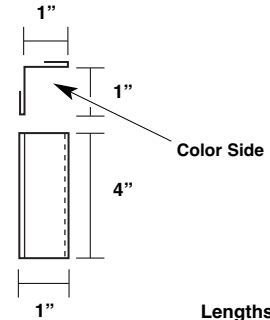

26 GA

Lengths:
0' - 4"

****Outside Corner Box for Standard Gutter**
Up to 3:12 Pitch

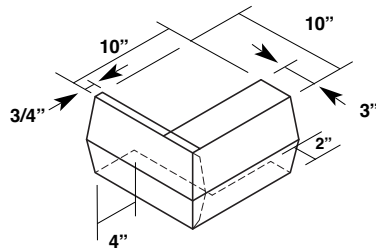

26 GA

(Right Hand Shown Left Hand Opposite)

**Snow guards required to prevent damage caused by sliding snow.

****Gutter Corner Box for Sculptured Eave**
Up to 6:12 Pitch

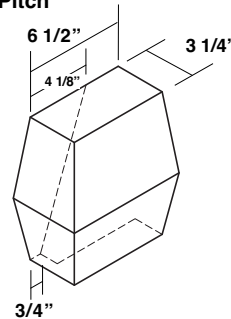

26 GA

(Right Hand Shown Left Hand Opposite)

**Snow guards required to prevent damage caused by sliding snow.

High Side Corner Box

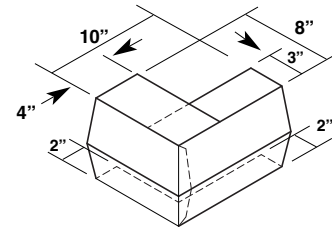

26 GA

(Right Hand Shown Left Hand Opposite)

****Outside Corner Box for Standard Gutter**
Above 3:12 to 6:12 Pitch

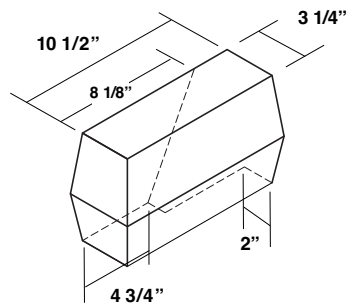

26 GA

(Right Hand Shown Left Hand Opposite)

**Snow guards required to prevent damage caused by sliding snow.

****Gutter**
Up to 3:12 Pitch

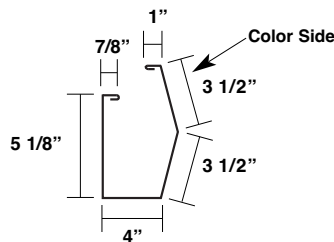

26 GA

**Snow guards required to prevent damage caused by sliding snow.

Lengths:
LF

****Gutter**
Above 3:12 to 6:12 Pitch

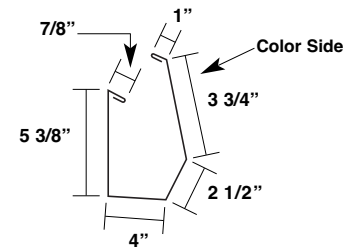

26 GA

**Snow guards required to prevent damage caused by sliding snow.

Lengths:
LF

Gutter Strap

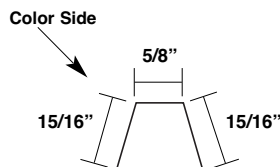

26 GA

Gutter End Cap
Up to 3:12 Pitch

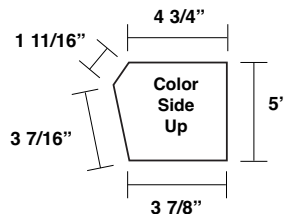

26 GA

(Right Hand Shown Left Hand Opposite)

Gutter End Cap
Above 3:12 to 6:12 Pitch

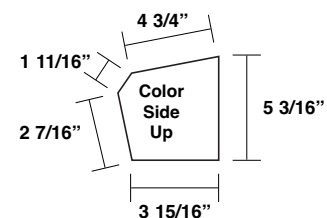

26 GA

(Right Hand Shown Left Hand Opposite)

MIRAGE

TRIM

<p>Adelanto Downspout</p>	<p>Adelanto Downspout Strap</p>	<p>Adelanto Aluminum Downspout Outlet</p> <p>Lengths: N/A</p>
----------------------------------	--	--

SPECIAL RAKE AND GUTTER TRIM

<p>5 1/2" Gutter Manufactured in Adelanto, CA</p> <p>**Snow guards required to prevent damage caused by sliding snow.</p> <p>Lengths: LF</p>	<p>5 1/2" Barge Manufactured in Adelanto, CA</p> <p>Lengths: LF</p>	<p>Mirage Gutter Clip Item #: 241429</p> <p>Lengths: N/A</p>
<p>Mirage 5 1/2" Barge Cleat Painted Item #: 206556 Bare Item #: 206557</p>	<p>Rainhead Gutter (Adelanto, CA)</p> <p>Lengths: 16"</p>	

ACCESSORIES

<p>Utility Eave Plate Item #: 221025</p> <p>Lengths: 10' - 0"</p>	<p>Mirage Clip Item #: 212674</p>	<p>#10 - 12 x 1" Type A Pancake Head Woodgrip - Plain Item #: 36116001</p>
--	--	---

*specify roof pitch

(H) Indicates an open hem - All other hems are closed.

MIRAGE

ACCESSORIES

#10 - 16 x 1" TEK2
Pancake Head 2/2 Quadrex
Self-Driller - Plain
Item #: 36117

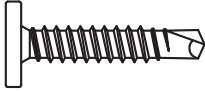

1/4 - 14 x 1 1/4"
TEK2 ZAC 3/8 HWH Plain
(Part # Varies by Color)

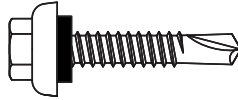

1/4 - 14 x 7/8"
LAPTEK ZAC
Self-Driller
(Part # Varies by Color)

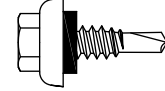

HHAB #14 - 10 x 1 1/2"
Type A ZAC Tapper
(Part # Varies by Color)

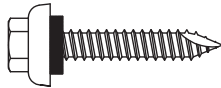

1/4 - 14 x 1 1/4"
Shoulder TEK2 3/8
HWH W/O Washer - Plain
Item #: 10975

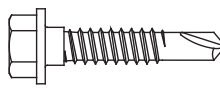

Butyl Bead Tape Sealant
1/4" x 5/16" x 20'
Item #: 95462

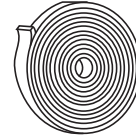

Butyl Tape Sealant
1/2" x 3/32" x 45'
Item #: 94680

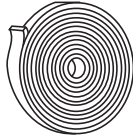

Butyl Tape Sealant
3/32" x 1" x 45'
Item #: 95335

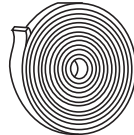

Titebond Caulk Sealant
(Part # varies by color)



Butyl Tube Sealant
Item #: 95342



43D Pop Rivet
(Part # Varies by Color)



Touch-Up Paint Pen
(Part # Varies by Color)



Mirage Outside Closure
Item #: 38622

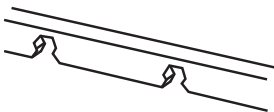

Lengths:
2' - 8"

Mirage Inside Closure
Item #: 38621

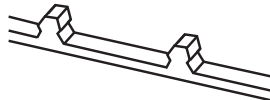

Lengths:
2' - 8"

Hem-Down Tool
Item #: 38618

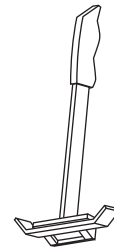

Hem-Up Tool
Item #: 38617

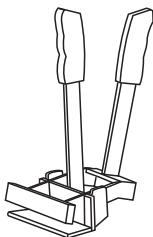

Mirage Notching Tool
Item #: 38619

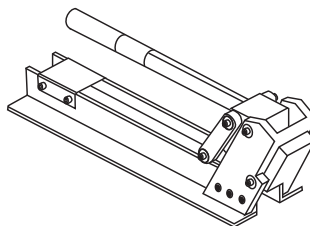

MIRAGE II

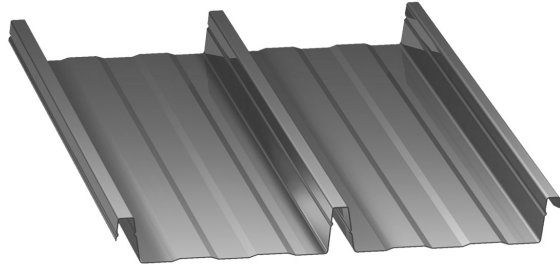

Mirage II

Mirage II Panel

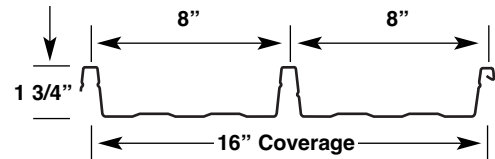

Mirage II Test Data. Section Properties or Load Tables

For any available Testing Data, Section Properties, or Load Tables, please visit www.mcelroymetal.com. For all other additional information, please contact the **McElroy Engineering Department at 1-800-950-9082**.

Mirage II Seam Detail

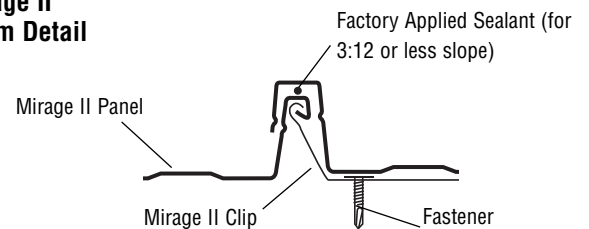

Details:

- Minimum Slope: 1/4:12
- Factory applied sealant is required in seam (side laps) at less than 3:12 slope
- Can be installed over solid deck or open framing

- Mirage II is produced in Ashburn, GA

Panel Options:

- Panel width: 16"
- Panel configurations: ribbed

- Coating:
 - Kynar 500® (PVDF)

- Substrate:
 - Standard 24 GA Galvalume®

Notes:

- Oil canning is a natural occurrence in metal panels and is not cause for panel rejection.
- Please contact a McElroy representative for specific pricing, lead times, special colors or gauges that may not be on a McElroy Metal color chart.
- Contents in this manual are subject to change without notice. To confirm this book is the most current copy, please visit McElroy's website at www.mcelroymetal.com.

MIRAGE II

TRIM

26 GA

Simple Eave*
Up to 6:12 Pitch

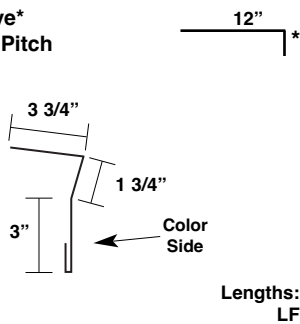

Sculptured Eave*
Up to 6:12 Pitch

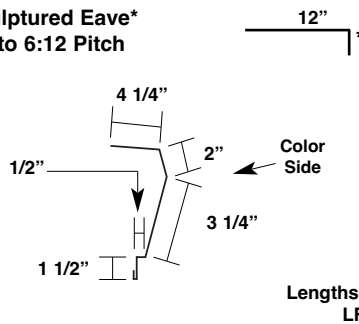

Rake Trim

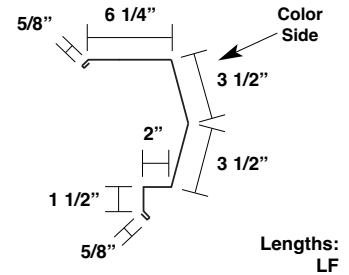

Rake Tie-In

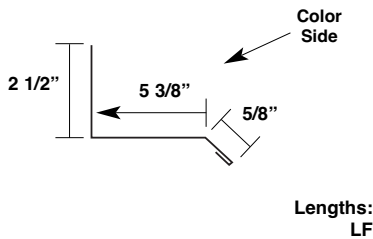

Rake Slide

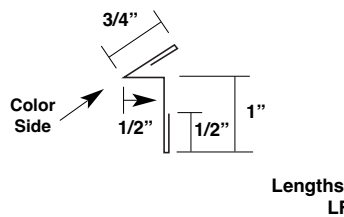

Rake Closure

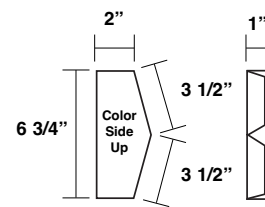

Zee Closure

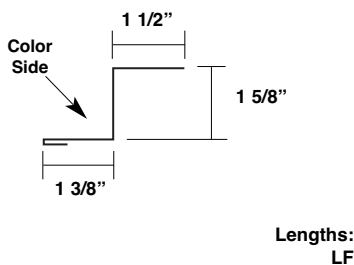

Floating High Side Tie-In Trim*
Up to 6:12 Pitch

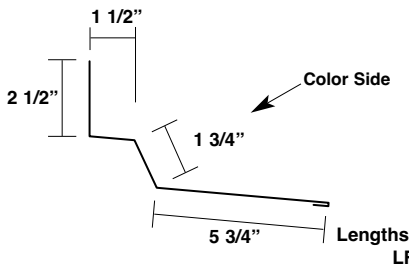

Alternate High Side Tie-In Trim*
Up to 6:12 Pitch

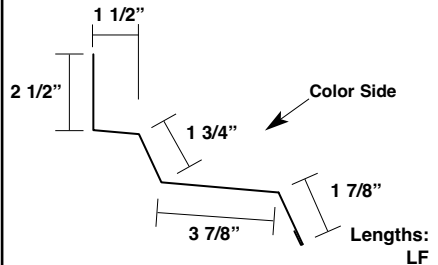

High Side Eave Trim*
Up to 6:12 Pitch

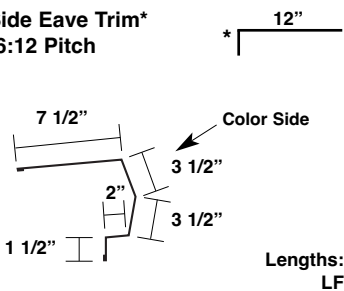

Alternate High Side Eave Trim*
Up to 6:12 Pitch

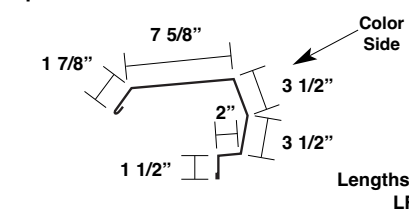

Fixed Ridge Cap*
Up to 6:12 Pitch

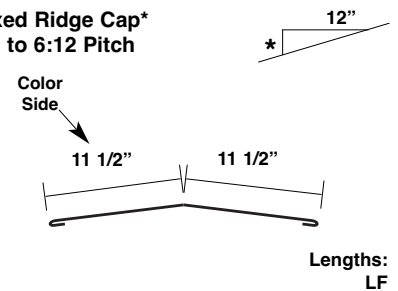

Alternate Fixed Ridge Cap*
Up to 6:12 Pitch

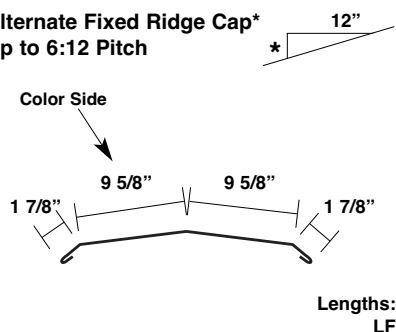

Floating Ridge Cap*
Up to 6:12 Pitch

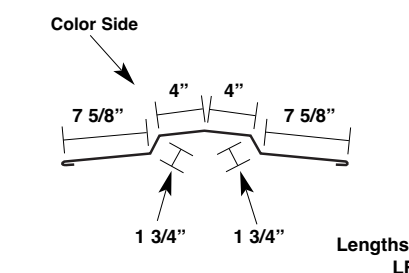

Alternate Floating Ridge Cap*
Up to 6:12 Pitch

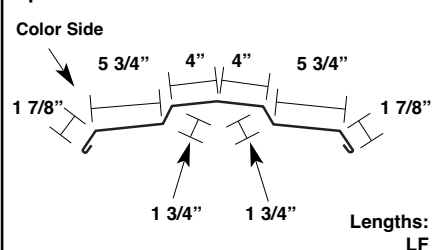

MIRAGE II

TRIM

Fixed Peak Box For 3:12
(Additional Roof Pitch Available - 1:12 to 6:12)

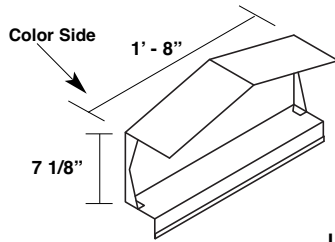

24 GA

Lengths:
1' - 8"

Floating Peak Box For 3:12
(Additional Roof Pitch Available - 1:12 to 6:12)

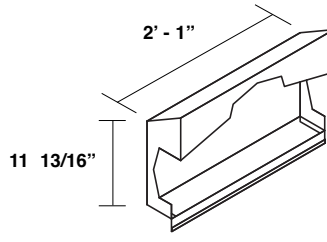

24 GA

Lengths:
2' - 1"

Cinch Angle

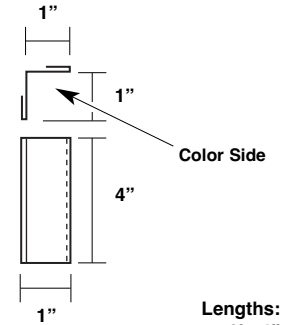

26 GA

Lengths:
0' - 4"

****Outside Corner Box for Standard Gutter Up to 3:12 Pitch**

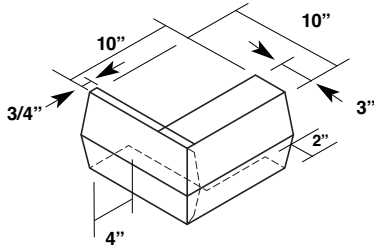

26 GA

(Right Hand Shown Left Hand Opposite)

**Snow guards required to prevent damage caused by sliding snow.

****Gutter Corner Box for Sculptured Eave Up to 6:12 Pitch**

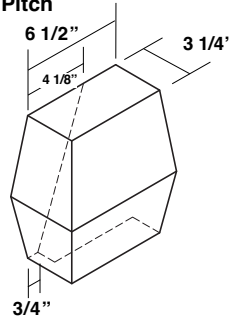

26 GA

(Right Hand Shown Left Hand Opposite)

**Snow guards required to prevent damage caused by sliding snow.

High Side Corner Box

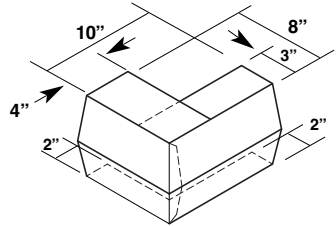

26 GA

(Right Hand Shown Left Hand Opposite)

****Outside Corner Box for Standard Gutter Above 3:12 to 6:12 Pitch**

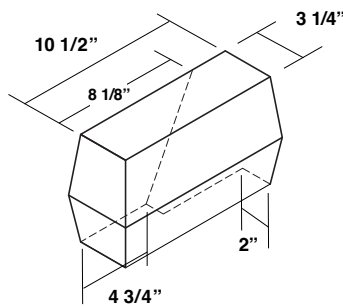

26 GA

(Right Hand Shown Left Hand Opposite)

**Snow guards required to prevent damage caused by sliding snow.

****Gutter Up to 3:12 Pitch**

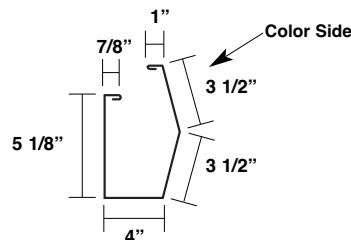

26 GA

**Snow guards required to prevent damage caused by sliding snow.

Lengths:
LF

****Gutter Above 3:12 to 6:12 Pitch**

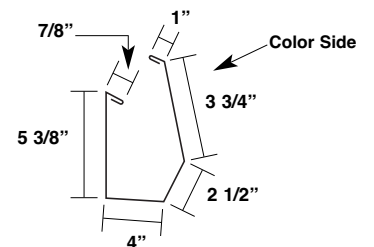

26 GA

**Snow guards required to prevent damage caused by sliding snow.

Lengths:
LF

Gutter Strap

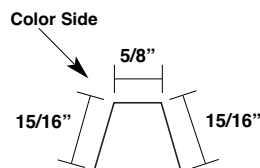

26 GA

Gutter End Cap Up to 3:12 Pitch

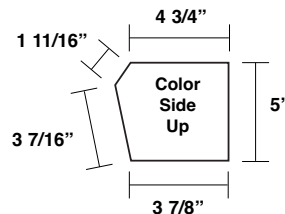

26 GA

(Right Hand Shown Left Hand Opposite)

Gutter End Cap Above 3:12 to 6:12 Pitch

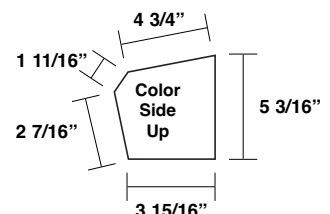

26 GA

(Right Hand Shown Left Hand Opposite)

MIRAGE II

TRIM

<p>Downspout BBPPS</p> <p>Only available in 26 Ga.</p> <p>Lengths: 14' - 3"</p>	<p>Downspout Strap BBPDSS</p> <p>Only available in 26 Ga.</p>	<p>Aluminum Downspout Outlet Box BBPOUT</p>
<p>Lock-Seam Downspout Outlet - Standard</p>	<p>Lock-Seam Downspout Strap</p> <p>Color Side</p>	<p>Lock-Seam Downspout</p> <p>24 GA (Ashburn, GA)</p> <p>Color Side</p> <p>Lengths: LF</p>

SPECIAL RAKE AND GUTTER TRIM

<p>7" Gutter Manufactured In Ashburn, GA</p> <p>Color Side</p> <p>**Snow guards required to prevent damage caused by sliding snow.</p> <p>Lengths: LF</p>	<p>7" Barge Manufactured in Ashburn, GA</p> <p>Color Side</p> <p>Lengths: LF</p>	<p>Mirage II Gutter Clip Item #: 38973</p> <p>Lengths: N/A</p>
<p>Mirage II Barge Clip Item #: 39020 (To be used with 7" Barge)</p> <p>Lengths: N/A</p>		

MIRAGE II

ACCESSORIES

<p>Utility Eave Plate Item #: 17477</p> <p>Lengths: 10' - 0''</p>	<p>Mirage II 8" Clip Item #: 38978</p> <p>Lengths: 8''</p>	<p>#10 - 12 x 1" Type A Pancake Head Woodgrip - Plain Item #: 36116</p>
<p>#10 - 16 x 1" TEK2 Pancake Head 2/2 Quadrex Self-Driller - Plain Item #: 36117</p>	<p>1/4 - 14 x 1 1/4" TEK2 ZAC 3/8 HWH Plain (Part # Varies by Color)</p>	<p>1/4 - 14 x 7/8" LAPTEK ZAC Self-Driller (Part # Varies by Color)</p>
<p>HHAB #14 - 10 x 1 1/2" Type A ZAC Tapper (Part # Varies by Color)</p>	<p>1/4 - 14 x 1 1/4" Shoulder TEK2 3/8 HWH W/O Washer - Plain Item #: 10975</p>	<p>Butyl Bead Tape Sealant 1/4" x 5/16" x 20' Item #: 95462</p>
<p>Butyl Tape Sealant 3/8" x 3/32" x 45' Item #: 95340</p>	<p>Butyl Tape Sealant 3/32" x 1" x 30' Item #: 95345</p>	<p>Titebond Caulk Sealant (Part # varies by color)</p>
<p>White Urethane Sealant Item #: 95320</p>	<p>Butyl Tube Sealant Item #: 95342</p>	<p>43D Pop Rivet (Part # Varies by Color)</p>
<p>Touch-Up Paint Pen (Part # Varies by Color)</p>	<p>Mirage II Outside Closure Item #: 39018</p> <p>Lengths: 2' - 8''</p>	<p>Mirage II Inside Closure Item #: 39017</p> <p>Lengths: 2' - 8''</p>
<p>Hem-Down Tool Item #: 38618</p>	<p>Hem-Up Tool Item #: 38617</p>	



☆ MANUFACTURING LOCATIONS ● SERVICE CENTERS ★ MANUFACTURING AND SERVICE CENTER



CORPORATE OFFICE

1500 HAMILTON RD.
BOSSIER CITY, LA 71111

MANUFACTURING LOCATIONS

- | | | | | |
|--------------|--------------------|------------------|----------------|-------------|
| ADELANTO, CA | ASHBURN, GA | BOSSIER CITY, LA | CLINTON, IL | DIAMOND, MO |
| HOUSTON, TX | LEWISPORT, KY | MARSHALL, MI | MAUSTON, WI | MERKEL, TX |
| | PEACHTREE CITY, GA | SUNNYVALE, TX | WINCHESTER, VA | |

MCELROY METAL SERVICE CENTER

- | | | | |
|--|--|---|---|
| 17031 Koala Road
Adelanto, CA 92301 | 5215 Leo St.
Alexandria, LA 71301 | 1007 Wilso Dr,
Baltimore, MD 21223 | 1500 Hamilton Rd.
Bossier City, LA 71111 |
| 3052 Yadkin Road
Chesapeake, VA 23323 | 9476 Meadowbrook Rd.
Clinton, IL 61727 | 3215 Highway 59
Diamond, MO 64840 | 390 N. Valley Dell Dr.
Fenton, MO 63026 |
| 409 Lovejoy Road
Ft. Walton Beach, FL 32548 | 3014 Lincoln Court
Garland, TX 75041 | 1440 Aldine Bender Road
Houston, TX 77032 | 10504 E. 59th Street
Indianapolis, IN 46236 |
| 9435 US Hwy. 60 W.
Lewisport, KY 42351 | 1020 Veterans Street
Mauston, WI 53948 | 5123 Terminal Dr.
McFarland, WI 53558 | 514 Cave Road
Nashville, TN 37210 |
| 8304 Hwy. 70 E.
North Little Rock, AR 72117 | 613 North Bierdeman Rd.
Pearl, MS 39208 | 7450 Tower Street
Richland Hills, TX 76118 | 8200 Berry Ave. Suite 100
Sacramento, CA 95828 |
| 1365 Dean Forest Rd.
Savannah, GA 31405 | 7355 Oakley Industrial Blvd.
Union City, GA 30291 | 1144 Silstar Rd.
West Columbia, SC 29170 | 325 McGhee Rd.
Winchester, VA 22603 |

Website: www.mcelroymetal.com • E-mail: info@mcelroymetal.com