

# MIRAGE II

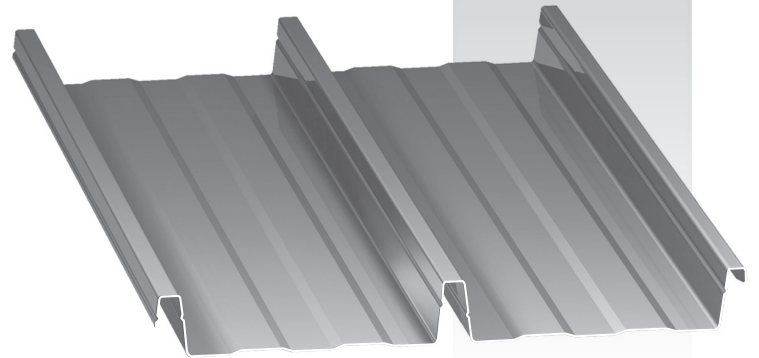

Panel/Trim /Accessories



# MIRAGE II

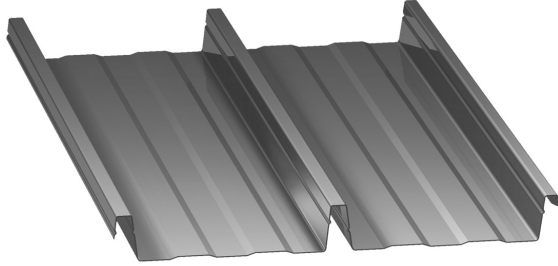

## Mirage II

## Mirage II Panel

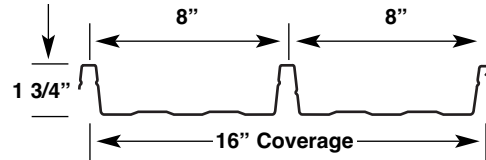

## Mirage II Test Data. Section Properties or Load Tables

For any available Testing Data, Section Properties, or Load Tables, please visit [www.mcelroymetal.com](http://www.mcelroymetal.com). For all other additional information, please contact the **McElroy Engineering Department at 1-800-950-9082**.

## Mirage II Seam Detail

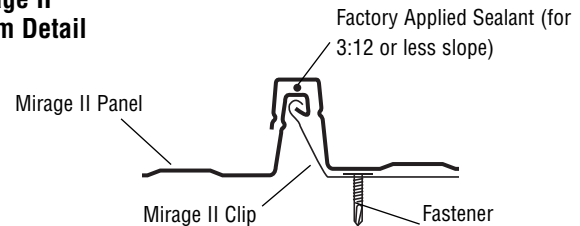

## Details:

- Minimum Slope: 1/4:12
- Factory applied sealant is required in seam (side laps) at less than 3:12 slope
- Can be installed over solid deck or open framing
- Mirage II is produced in Adelanto, CA and Ashburn, GA

## Panel Options:

- Panel width: 16"
- Panel configurations: ribbed
- Coating:
  - Kynar 500® (PVDF)
- Substrate:
  - Standard 24 GA Galvalume®

## Notes:

- Oil canning is a natural occurrence in metal panels and is not cause for panel rejection.
- Please contact a McElroy representative for specific pricing, lead times, special colors or gauges that may not be on a McElroy Metal color chart.
- Contents in this manual are subject to change without notice. To confirm this book is the most current copy, please visit McElroy's website at [www.mcelroymetal.com](http://www.mcelroymetal.com).

# MIRAGE II

## TRIM

26 GA

Simple Eave\*  
Up to 6:12 Pitch

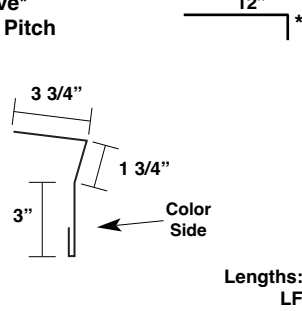

Sculptured Eave\*  
Up to 6:12 Pitch

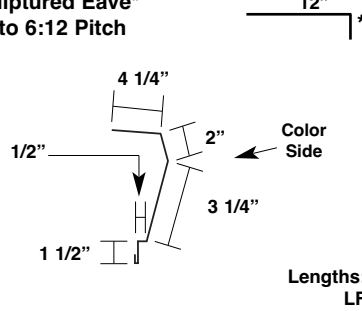

Rake Trim

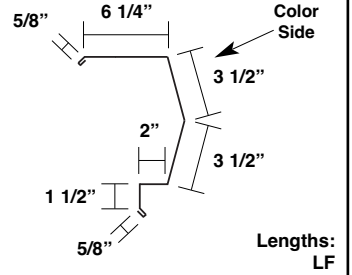

Rake Tie-In

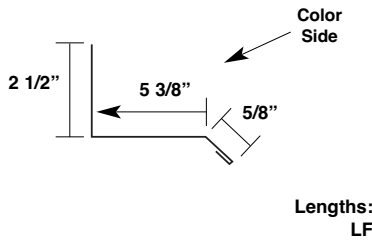

Rake Slide

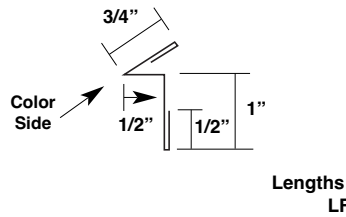

Rake Closure

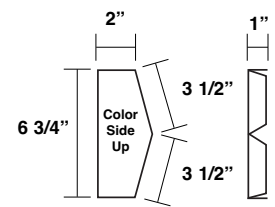

Zee Closure

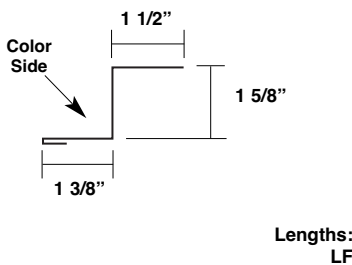

Floating High Side  
Tie-In Trim\*  
Up to 6:12 Pitch

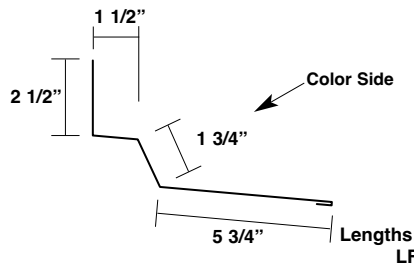

Alternate High Side  
Tie-In Trim\*  
Up to 6:12 Pitch

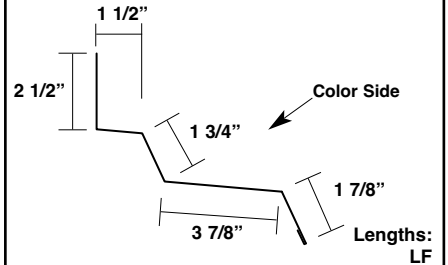

High Side Eave Trim\*  
Up to 6:12 Pitch

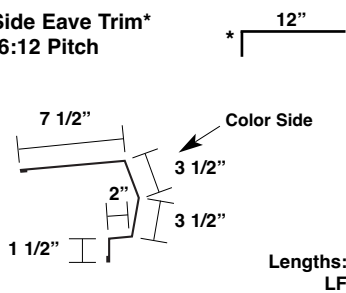

Alternate High Side  
Eave Trim\*  
Up to 6:12 Pitch

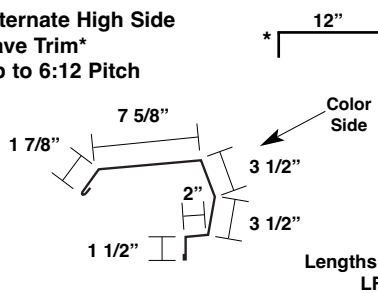

Fixed Ridge Cap\*  
Up to 6:12 Pitch

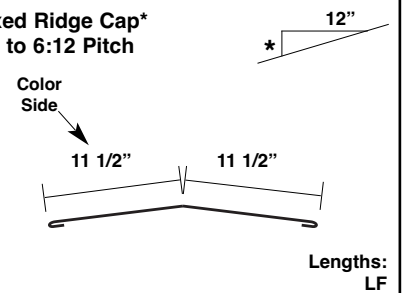

Alternate Fixed Ridge Cap\*  
Up to 6:12 Pitch

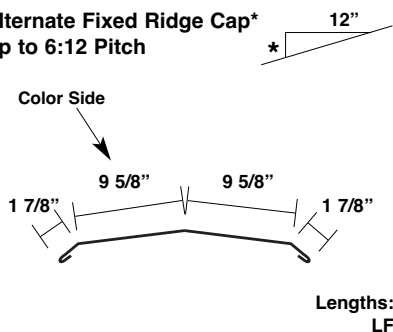

Floating Ridge Cap\*  
Up to 6:12 Pitch

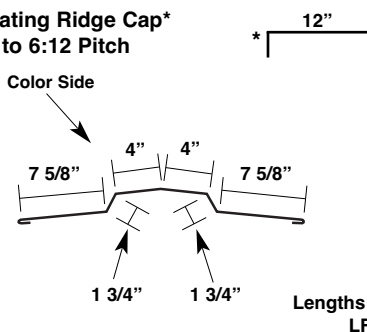

Alternate Floating  
Ridge Cap\*  
Up to 6:12 Pitch

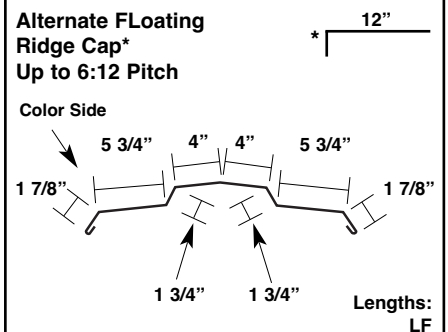

\*specify roof pitch

(H) Indicates an open hem - All other hems are closed.

# MIRAGE II

## TRIM

**Fixed Peak Box For 3:12**  
(Additional Roof Pitch Available -  
1:12 to 6:12)

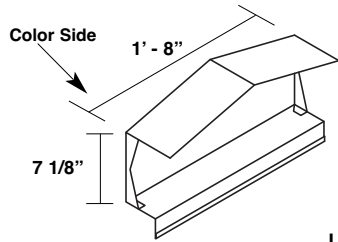

24 GA

Lengths:  
1' - 8"

**Floating Peak Box For 3:12**  
(Additional Roof Pitch Available -  
1:12 to 6:12)

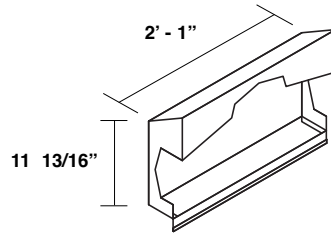

24 GA

Lengths:  
2' - 1"

**Cinch Angle**

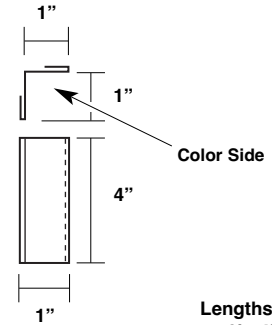

26 GA

Lengths:  
0' - 4"

**\*\*Outside Corner Box for  
Standard Gutter  
Up to 3:12 Pitch**

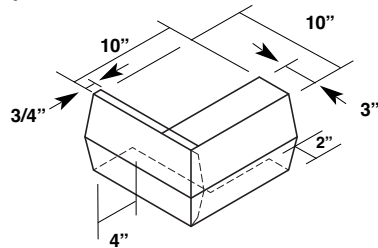

26 GA

(Right Hand Shown Left Hand Opposite)

\*\*Snow guards required to prevent  
damage caused by sliding snow.

**\*\*Gutter Corner Box for Sculptured Eave  
Up to 6:12 Pitch**

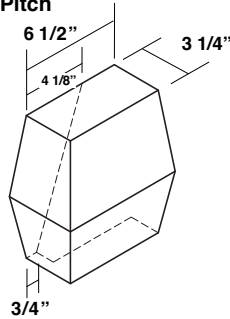

26 GA

(Right Hand Shown Left Hand Opposite)

\*\*Snow guards required to prevent  
damage caused by sliding snow.

**High Side Corner Box**

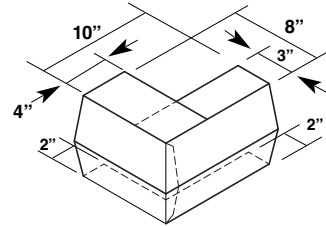

26 GA

(Right Hand Shown Left Hand Opposite)

**\*\*Outside Corner Box for Standard Gutter  
Above 3:12 to 6:12 Pitch**

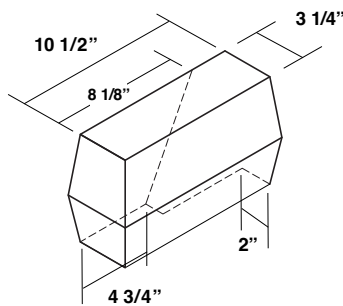

26 GA

(Right Hand Shown Left Hand Opposite)

\*\*Snow guards required to prevent  
damage caused by sliding snow.

**\*\*Gutter  
Up to 3:12 Pitch**

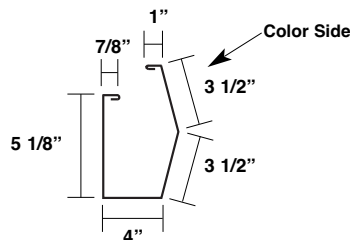

26 GA

\*\*Snow guards required to prevent  
damage caused by sliding snow.

Lengths:  
LF

**\*\*Gutter  
Above 3:12 to 6:12 Pitch**

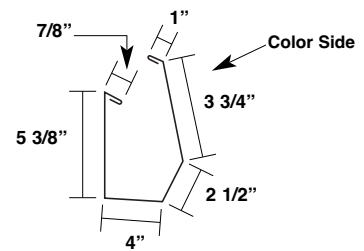

26 GA

\*\*Snow guards required to prevent  
damage caused by sliding snow.

Lengths:  
LF

**Gutter Strap**

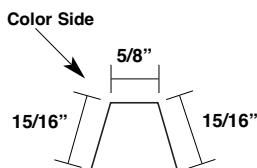

26 GA

**Gutter End Cap  
Up to 3:12 Pitch**

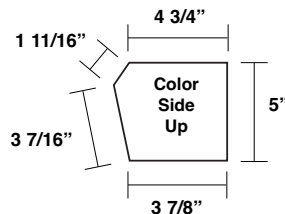

26 GA

(Right Hand Shown Left Hand Opposite)

**Gutter End Cap  
Above 3:12 to 6:12 Pitch**

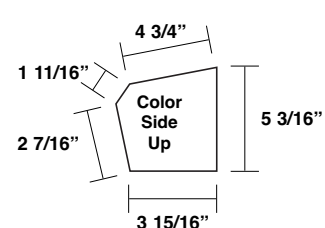

26 GA

(Right Hand Shown Left Hand Opposite)

# MIRAGE II

## TRIM

**Downspout  
BBPPS**

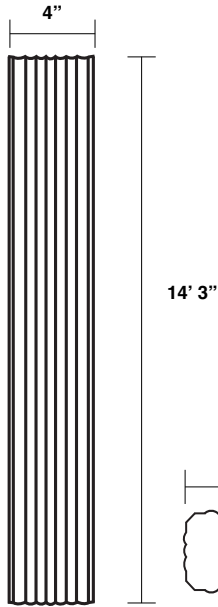

Only available in 26 Ga.

Lengths:  
14' - 3"

**Downspout Strap  
BBPDSS**

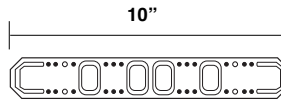

Only available in 26 Ga.

**Aluminum Downspout  
Outlet Box  
BBPOUT**

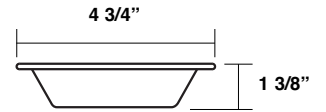

**3" x 4"  
Downspout Elbow  
A-Style  
BBPELA**

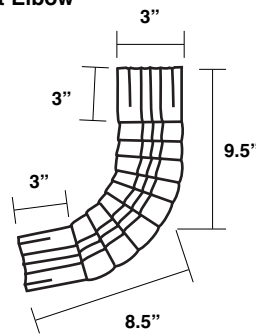

Only available in 26 Ga.

**Lock-Seam Downspout**

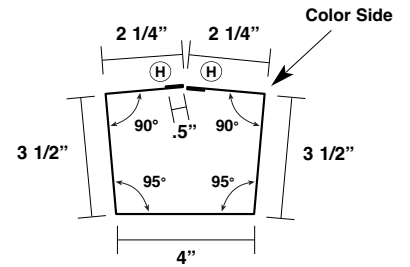

24 GA  
(Ashburn, GA)

Lengths:  
LF

**Lock-Seam Downspout Outlet -  
Standard**

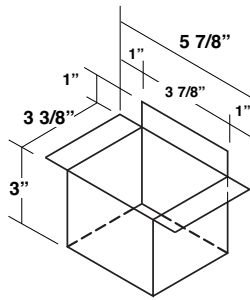

**Lock-Seam Downspout Strap**

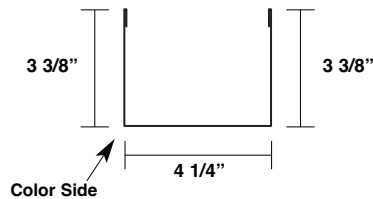

### Notes:

\*specify roof pitch

(H) Indicates an open hem - All other hems are closed.

# MIRAGE II

## SPECIAL RAKE AND GUTTER TRIM

**5 1/2" Gutter**  
Manufactured in Adelanto, CA

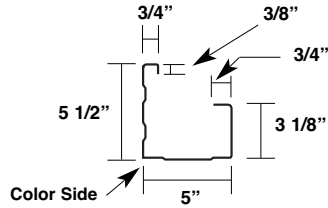

\*\*Snow guards required to prevent damage caused by sliding snow. Lengths: LF

**5 1/2" Barge**  
Manufactured in Adelanto, CA

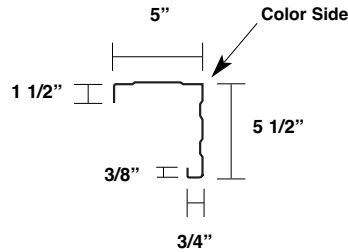

Lengths: LF

**5 1/2" Barge Cleat**  
Painted Item #: 206556  
Bare Item #: 206557

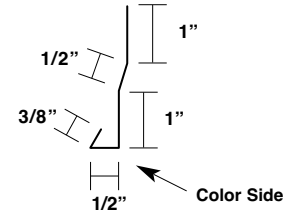

**Rainhead Gutter**  
(Manufactured in Adelanto, CA)

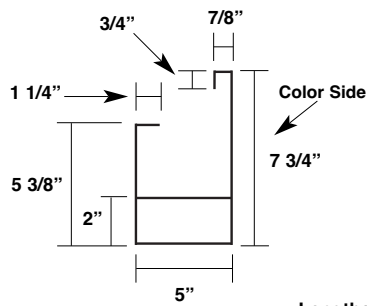

Lengths: 16"

**7" Gutter**  
Manufactured in Ashburn, GA

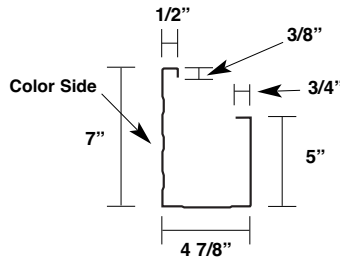

\*\*Snow guards required to prevent damage caused by sliding snow. Lengths: LF

**7" Barge**  
Manufactured in Ashburn, GA

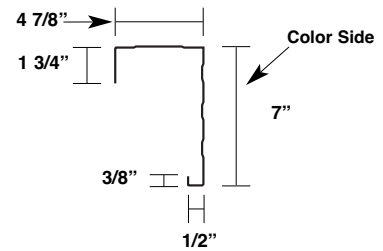

Lengths: LF

**Gutter Clip**  
Item #: 38973



Gutter Clip used on both 5 1/2" and 7" Gutter

Lengths: N/A

**Barge Clip**  
Item #: 39020  
(To be used with 7" Barge)

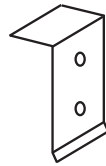

Lengths: N/A

### Notes:

# MIRAGE II

## ACCESSORIES

Utility Eave Plate  
Item #: 17477

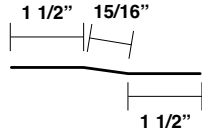

Lengths:  
10' - 0"

Mirage II 8" Clip  
Item #: 38978



Lengths:  
8"

#10 - 12 x 1" Type A Pancake Head Woodgrip - Plain  
Item #: 36116001

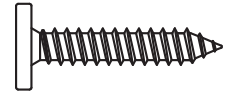

#10 - 16 x 1" TEK2 Pancake Head 2/2 Quadrex Self-Driller - Plain  
Item #: 36117



1/4 - 14 x 1 1/4" TEK2 ZAC 3/8 HWH Plain  
(Part # Varies by Color)



1/4 - 14 x 7/8" LAPTEK ZAC Self-Driller  
(Part # Varies by Color)

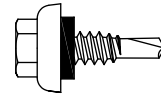

HHAB #14 - 10 x 1 1/2" Type A ZAC Tapper  
(Part # Varies by Color)

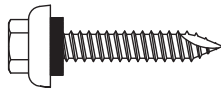

1/4 - 14 x 1 1/4" Shoulder TEK2 3/8 HWH W/O Washer - Plain  
Item #: 10975

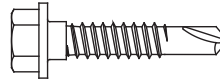

Butyl Bead Tape Sealant 1/4" x 5/16" x 20'  
Item #: 95462

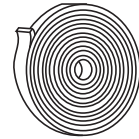

Butyl Tape Sealant 3/8" x 3/32" x 45'  
Item #: 95340

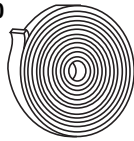

Butyl Tape Sealant 3/32" x 1" x 30'  
Item #: 95345

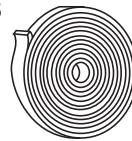

Titebond Caulk Sealant  
(Part # varies by color)



White Urethane Sealant  
Item #: 95320



Butyl Tube Sealant  
Item #: 95342



43D Pop Rivet  
(Part # Varies by Color)



Touch-Up Paint Pen  
(Part # Varies by Color)



Mirage II Outside Closure  
Item #: 39018 Without Adhesive  
250258 With Adhesive

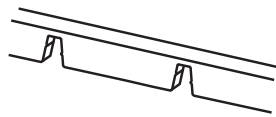

Lengths:  
2' - 8"

Mirage II Inside Closure  
Item #: 39017 Without Adhesive  
250257 With Adhesive

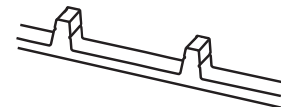

Lengths:  
2' - 8"

### Notes:

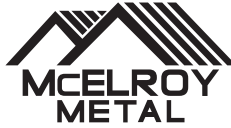

☆ MANUFACTURING LOCATIONS ● SERVICE CENTERS ★ MANUFACTURING AND SERVICE CENTER



**CORPORATE OFFICE**  
1500 HAMILTON RD.  
BOSSIER CITY, LA 71111

**MANUFACTURING LOCATIONS**

- |              |                    |                  |                |             |
|--------------|--------------------|------------------|----------------|-------------|
| ADELANTO, CA | ASHBURN, GA        | BOSSIER CITY, LA | CLINTON, IL    | DIAMOND, MO |
| HOUSTON, TX  | LEWISPORT, KY      | LOCKHART, TX     | MARSHALL, MI   | MAUSTON, WI |
| MERKEL, TX   | PEACHTREE CITY, GA | SUNNYVALE, TX    | WINCHESTER, VA |             |

**MCELROY METAL**  
**SERVICE**  
CENTER

17031 Koala Road Adelanto, CA 92301	5215 Leo St. Alexandria, LA 71301	1007 Wilso Dr, Baltimore, MD 21223	1500 Hamilton Rd. Bossier City, LA 71111
3052 Yadkin Road Chesapeake, VA 23323	9476 Meadowbrook Rd. Clinton, IL 61727	3215 Highway 59 Diamond, MO 64840	390 N. Valley Dell Dr. Fenton, MO 63026
409 Lovejoy Road Ft. Walton Beach, FL 32548	3014 Lincoln Court Garland, TX 75041	1440 Aldine Bender Road Houston, TX 77032	10504 E. 59th Street Indianapolis, IN 46236
32 Industrial Circle Lancaster, PA 17601	9435 US Hwy. 60 W. Lewisport, KY 42351	2701 Cahill Street Lockhart, TX 78644	1020 Veterans Street Mauston, WI 53948
5123 Terminal Dr. McFarland, WI 53558	514 Cave Road Nashville, TN 37210	8304 Hwy. 70 E. North Little Rock, AR 72117	613 North Bierdeman Rd. Pearl, MS 39208
8511 Industrial Drive Pearland, TX 77584	2755 Hwy 60 Pendergrass, GA 30567	7450 Tower Street Richland Hills, TX 76118	8200 Berry Ave. Suite 100 Sacramento, CA 95828
1365 Dean Forest Rd. Savannah, GA 31405	7355 Oakley Industrial Blvd. Union City, GA 30291	1144 Silstar Rd. West Columbia, SC 29170	325 McGhee Rd. Winchester, VA 22603

Website: [www.mcelroymetal.com](http://www.mcelroymetal.com) • E-mail: [info@mcelroymetal.com](mailto:info@mcelroymetal.com)