

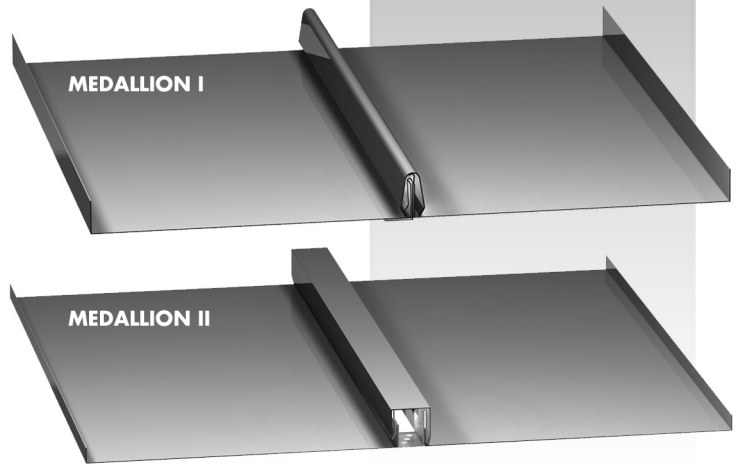

MEDALLION II MEDALLION I



Panel / Trim /Accessories



MEDALLION I

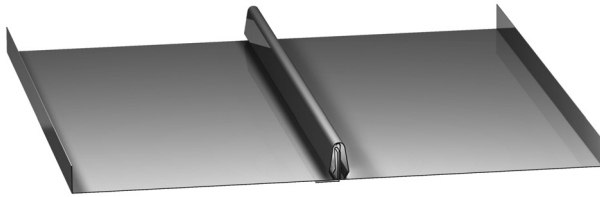



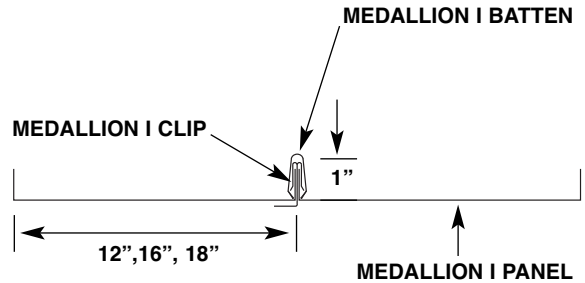

Medallion I

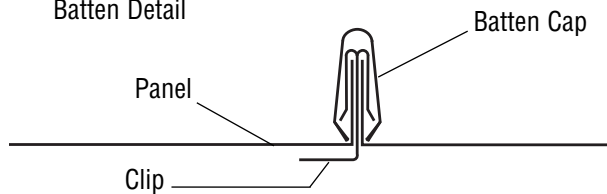

Medallion I
Seam &
Batten Detail



Medallion I Pan Conditions

MEDALLION I STRIATED*	 12", 16", 18"
MEDALLION I FLAT PAN	 12", 16", 18"
MEDALLION I DOUBLE PENCIL RIBS	 16" and 18" Only
MEDALLION I SINGLE PENCIL RIB	 12" Only

*Recommended Pan Condition

For any available Testing Data, Section Properties, or Load Tables, please visit www.mcelroymetal.com. For additional information, please contact the **McElroy Engineering Department** at 1-800-950-9082.

Details:

- Minimum slope: 3:12
- Must be installed over solid decking
- Curving: Medallion I only - minimum radius 30"
- Oil canning is a natural occurrence in metal panels and is not a cause for panel rejection

Panel Options:

- Panel width: 12", 16", and 18"
- Panel configurations: striated, ribbed or flat pan (striated recommended)
- Coating:
 - Kynar 500® (PVDF)
- Substrate:
 - Standard 24 GA Galvalume®

Notes:

- Please contact a McElroy representative for specific pricing, lead times, special colors or gauges that may not be on a McElroy Metal color chart.
- Contents in this manual are subject to change without notice. To confirm this book is the most current copy, please visit McElroy's website at www.mcelroymetal.com.

MEDALLION II

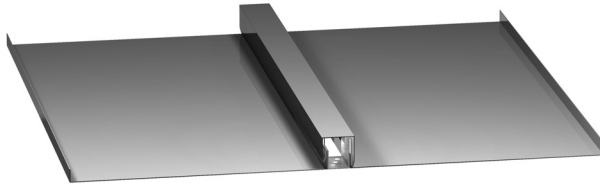

Medallion II

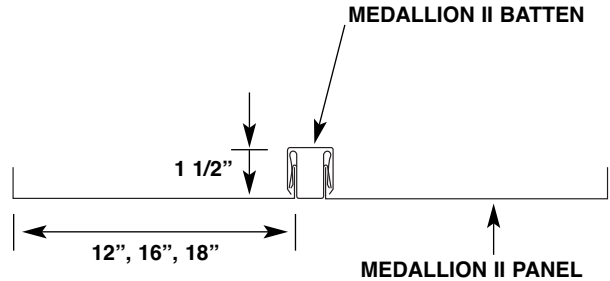

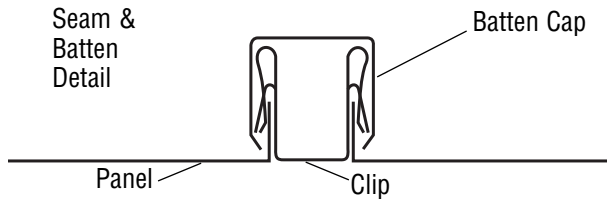

Cover width is pan width plus 1".

Medallion II
Seam &
Batten
Detail

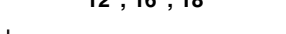
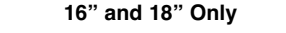

Medallion II Pan Conditions

MEDALLION II STRIATED*	
	12", 16", 18"
MEDALLION II FLAT PAN	
	12", 16", 18"
MEDALLION II DOUBLE PENCIL RIBS	
	16" and 18" Only
MEDALLION II SINGLE PENCIL RIB	
*Recommended Pan Condition	12" Only

For any available Testing Data, Section Properties, or Load Tables, please visit www.mcelroymetal.com. For additional information, please contact the **McElroy Engineering Department at 1-800-950-9082**.

Details:

- Minimum slope: 3:12
- Must be installed over solid decking
- Curving: Medallion I only - minimum radius 30"
- Oil canning is a natural occurrence in metal panels and is not a cause for panel rejection

Panel Options:

- Panel width: 12", 16", and 18"
- Panel configurations: striated, ribbed or flat pan (striated recommended)
- Coating:
 - Kynar 500® (PVDF)
- Substrate:
 - Standard 24 GA Galvalume®

Notes:

- Please contact a McElroy representative for specific pricing, lead times, special colors or gauges that may not be on a McElroy Metal color chart.
- Contents in this manual are subject to change without notice. To confirm this book is the most current copy, please visit McElroy's website at www.mcelroymetal.com.

MEDALLION I

TRIM

24 GA

**Soffit Base Trim
MDSB**

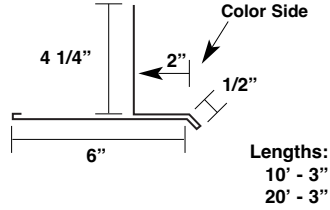

**Outside Corner
MDOC**

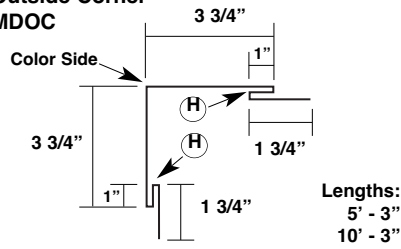

**Inside Corner
MDIC**

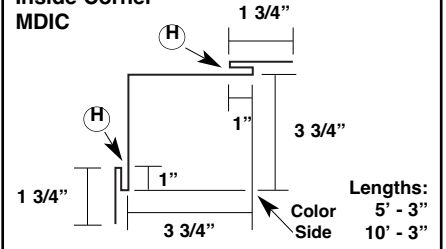

**Eave Trim*
MDET**

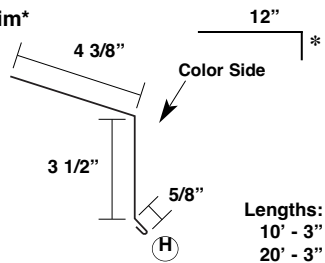

**Eave Drip/Rake Trim*
MDED1**

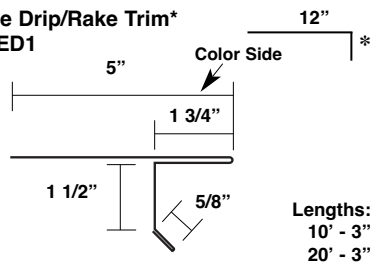

**Eave Drip/Rake Trim*
MDED3**

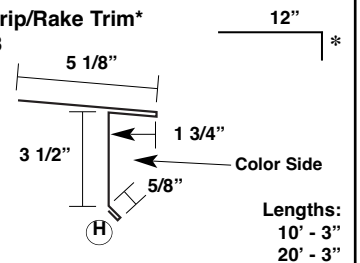

**Perimeter Cleat
MDPC**

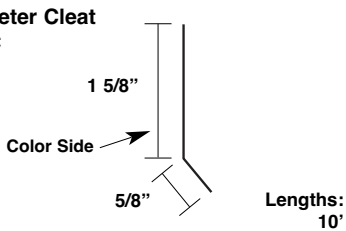

**Perimeter Zee Trim
M1PZ**

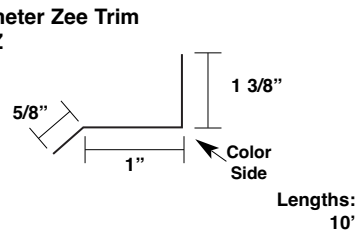

**Valley Trim*
MDVT**

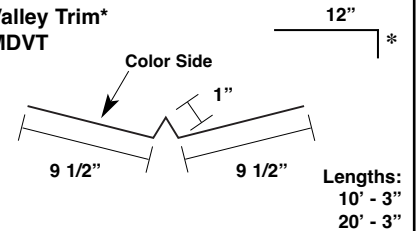

**Offset Cleat
MDOF**

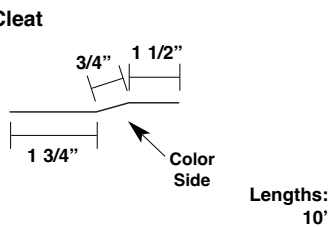

**Rake Trim
M1RT**

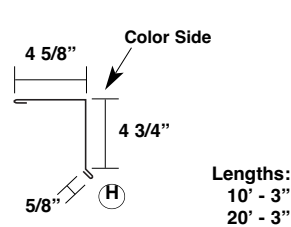

**Alternate Rake Trim
MDAR**

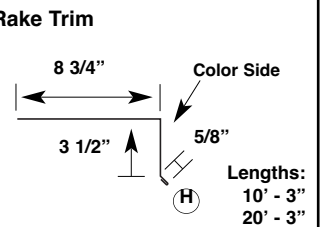

**Rake Tie-In Trim
MDEW**

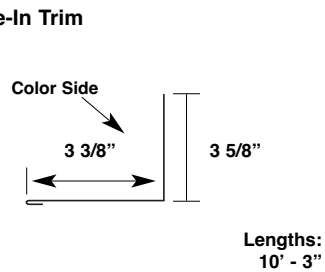

**Zee Closure
M1ZC**

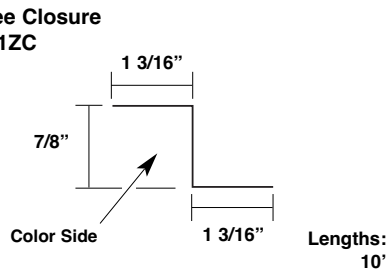

**High Side Trim*
M1HS**

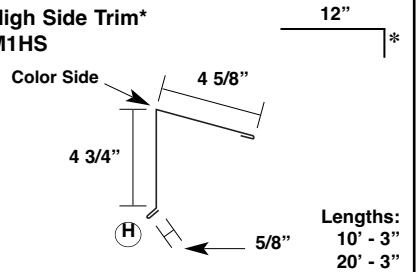

**High Side Tie-In Trim*
MDSW**

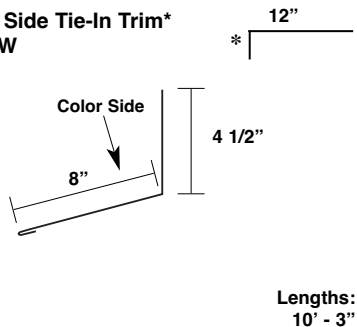

**Hip Flashing*
MDHF**

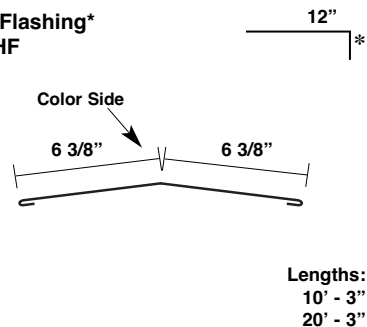

**Ridge Flashing*
MDRF**

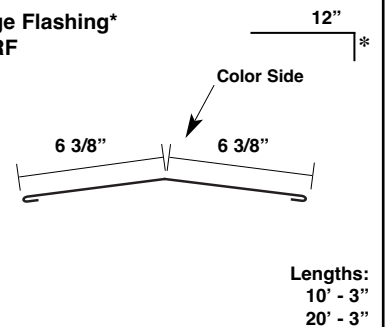

*specify roof pitch

(H) Indicates an open hem - All other hems are closed.

MEDALLION I

TRIM

24 GA

****Face Mounted Gutter
MDFMG**

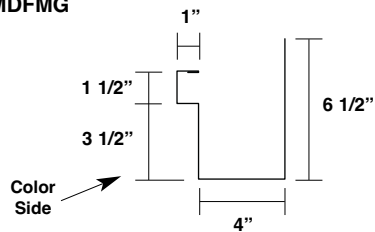

**Snow guards required to prevent damage caused by sliding snow.

Lengths:
10' - 3"
20' - 3"

****Flanged Gutter*
MDFLG**

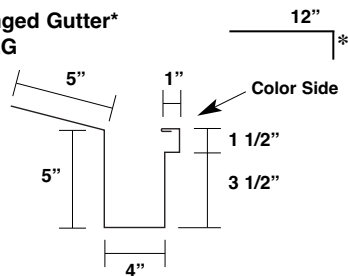

**Snow guards required to prevent damage caused by sliding snow.

Lengths:
10' - 3"
20' - 3"

**Gutter Strap
MD-GS**

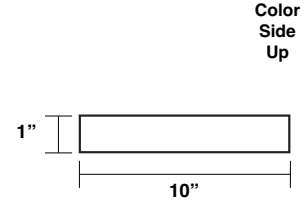

Color
Side
Up

Lengths:
10"

**Gutter End Cap
MDGEC**

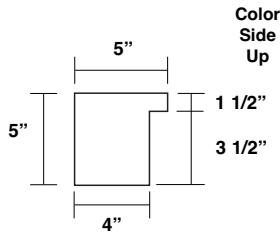

Color
Side
Up

26 Ga.

**Aluminium Downspout Outlet
BBPOUT**

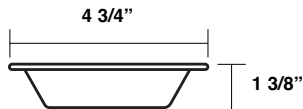

**Downspout 3" x 4"
26 Ga. = BBPDS**

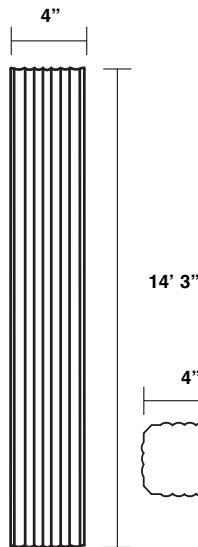

Lengths:
14' - 3"

**Downspout Strap
BBPDSS**

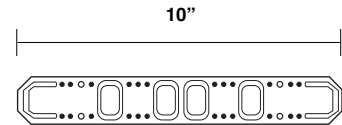

Lengths:
10"

Only available in 26 Ga.

**3" x 4" Downspout Elbow A-Style
26 Ga. = BBPELA**

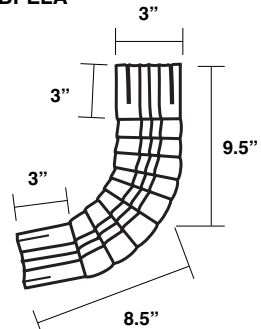

29 Ga. only available at the
Marshall and Lewisport locations.

Notes:

*specify roof pitch

Ⓜ Indicates an open hem - All other hems are closed.

MEDALLION II

TRIM

24 GA

Soffit Base Trim
MDSB

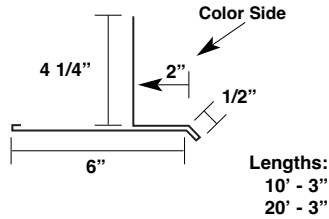

Outside Corner
MDOC

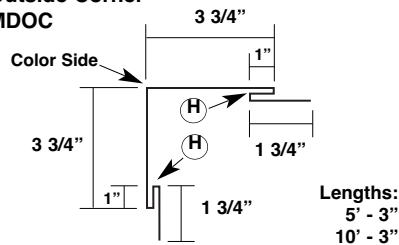

Inside Corner
MDIC

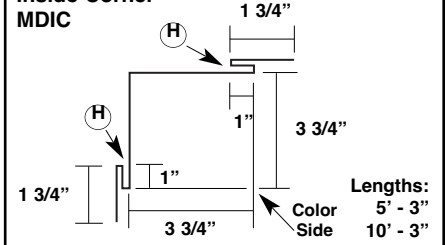

Eave Trim*
MDET

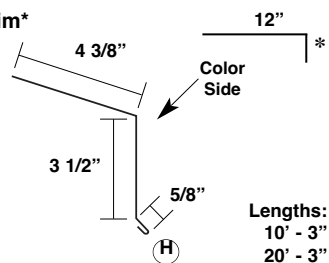

Eave Drip/Rake Trim*
MDED1

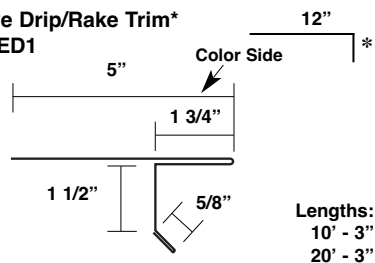

Eave Drip/Rake Trim*
MDED3

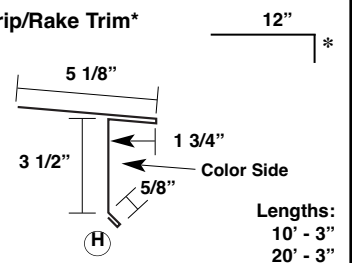

Perimeter Cleat
MDPC

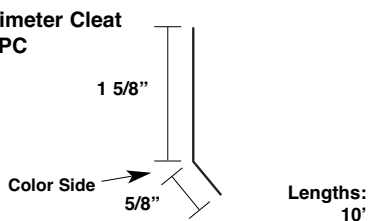

Perimeter Zee Trim
M2PZ

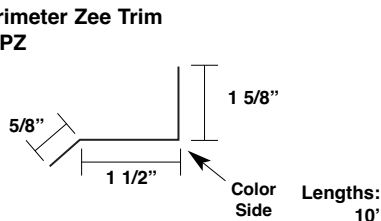

Valley Trim*
MDVT

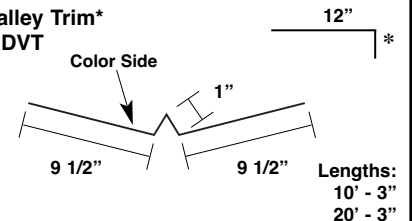

Offset Cleat
MDOF

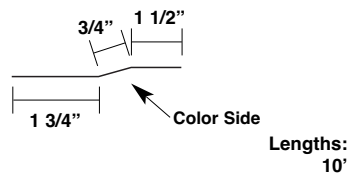

Rake Trim
M2RT

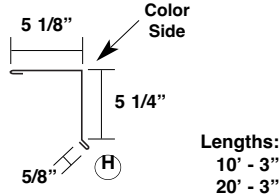

Alternate Rake Trim
MDAR

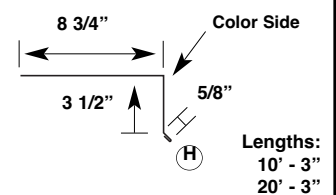

Rake Tie-In Trim
MDEW

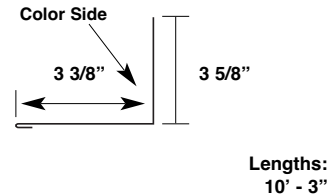

Zee Closure
M2ZC

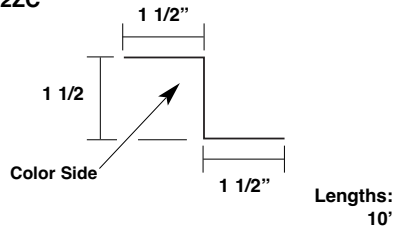

High Side Trim*
M2HS

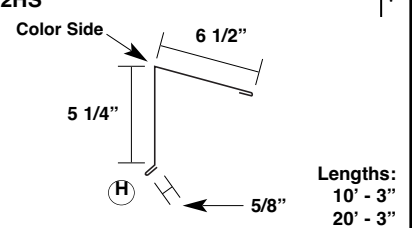

High Side Tie-In Trim*
MDSW

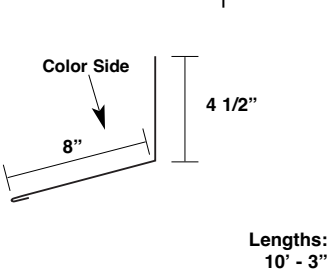

Hip Flashing*
MDHF

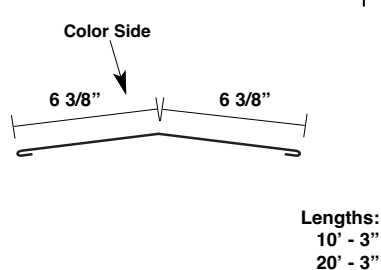

Ridge Flashing*
MDRF

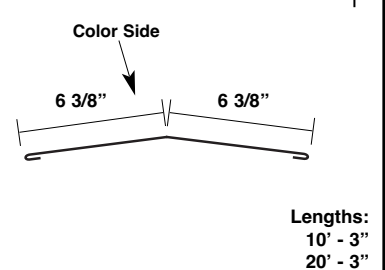

*specify roof pitch

(H) Indicates an open hem - All other hems are closed.

MEDALLION II

TRIM

24 GA

****Face Mounted Gutter**
MDFMG

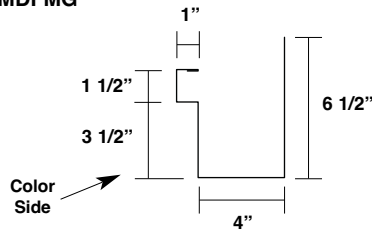

**Snow guards required to prevent damage caused by sliding snow.

Lengths:
10' - 3"
20' - 3"

****Flanged Gutter***
MDFLG

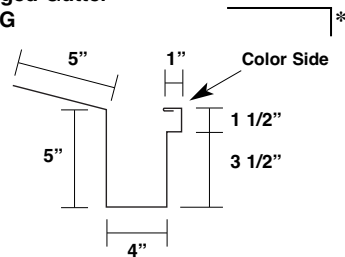

**Snow guards required to prevent damage caused by sliding snow.

Lengths:
10' - 3"
20' - 3"

Gutter Strap
MD-GS

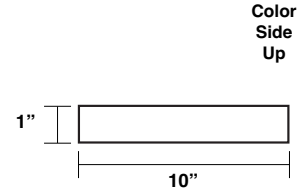

Lengths:
10"

Gutter End Cap
MDGEC

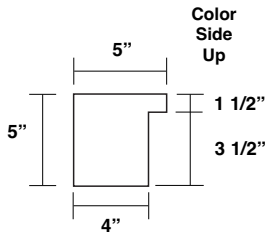

26 Ga.

Aluminum Downspout Outlet
BBPOUT

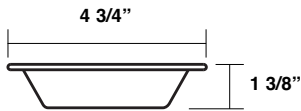

Downspout 3" x 4"
26 Ga. = BBPDS

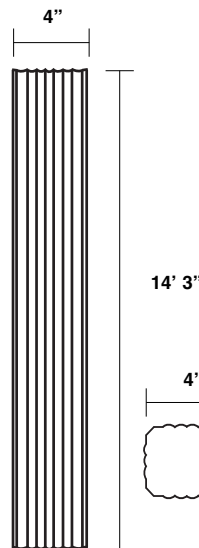

Lengths:
14' - 3"

Downspout Strap
BBPDSS

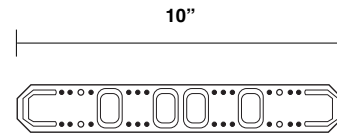

Only available in 26 Ga.

Lengths:
10"

3" x 4" Downspout Elbow A-Style
26 Ga. = BBPELA

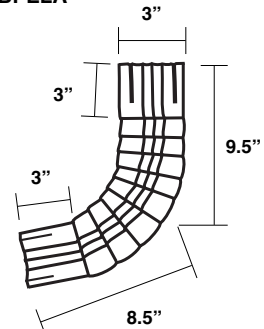

29 Ga. only available at the Marshall and Lewisport locations.

Notes:

MEDALLION I & II

ACCESSORIES

26 GA

Bearing Plate
 Item #: 94599 Primed
 Item #: 203541 Galvanized

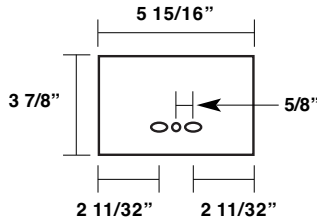

#9 - 15 x 1" Woodgrip
 W/O Washer - Plain
 Item #: 36115



1/4 - 14 x 1 1/4" TEK 2
 W/O Washer - Plain
 Item #: 10969



#10 - 12 x 1" Type A
 Pancake Head
 Woodgrip
 Item #: 36116



#10 - 16 x 1" TEK2
 Pancake Head
 Self-Driller
 Item #: 36117



1/4" - 14 x 7/8" LAPTEK ZAC
 Self-Driller
 (Part # Varies by Color)

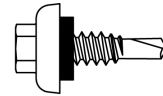

43D Pop Rivets
 (Part # Varies by Color)

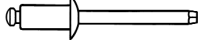

Butyl Tape Sealant
 3/32" x 1" x 45'
 Item #: 95335

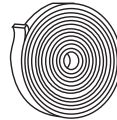

Titebond Caulk Sealant
 (Part # varies by color)



White Urethane Sealant
 Item #: 95320



Sikalastomer Tube Sealant
 Item #: 95342



Hemming Tool
 Item #: 36120

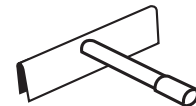

Touch-Up Paint Pen
 (Part # Varies by Color)





MEDALLION I BATTEN and CLIP

**BATTEN &
CLIP**

26 GA

Medallion I Clip
Item #: 36500

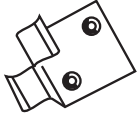

Medallion I Batten

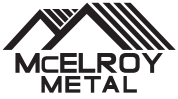
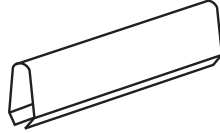

MEDALLION II BATTEN and CLIP

**BATTEN &
CLIP**

Medallion II Clip
Item #: 36510

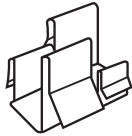

Medallion II Batten

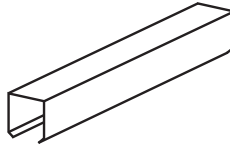

Notes:



MEDALLION I & II

Notes:

A large, empty rectangular area intended for handwritten notes, framed by a thin black border.

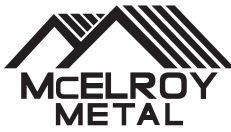

☆ MANUFACTURING LOCATIONS ● SERVICE CENTERS ★ MANUFACTURING AND SERVICE CENTER



CORPORATE OFFICE
1500 HAMILTON RD.
BOSSIER CITY, LA 71111

MANUFACTURING LOCATIONS

ADELANTO, CA	ASHBURN, GA	BOSSIER CITY, LA	CLINTON, IL	DIAMOND, MO
HOUSTON, TX	LEWISPORT, KY	MARSHALL, MI	MAUSTON, WI	MERKEL, TX
	PEACHTREE CITY, GA	SUNNYVALE, TX	WINCHESTER, VA	

**MCELROY METAL
SERVICE
CENTER**

17031 Koala Road Adelanto, CA 92301	5215 Leo St. Alexandria, LA 71301	1007 Wilso Dr, Baltimore, MD 21223	1500 Hamilton Rd. Bossier City, LA 71111
3052 Yadkin Road Chesapeake, VA 23323	9476 Meadowbrook Rd. Clinton, IL 61727	3215 Highway 59 Diamond, MO 64840	390 N. Valley Dell Dr. Fenton, MO 63026
409 Lovejoy Road Ft. Walton Beach, FL 32548	3014 Lincoln Court Garland, TX 75041	1440 Aldine Bender Road Houston, TX 77032	10504 E. 59th Street Indianapolis, IN 46236
9435 US Hwy. 60 W. Lewisport, KY 42351	1020 Veterans Street Mauston, WI 53948	5123 Terminal Dr. McFarland, WI 53558	514 Cave Road Nashville, TN 37210
8304 Hwy. 70 E. North Little Rock, AR 72117	613 North Bierdeman Rd. Pearl, MS 39208	8511 Industrial Drive Pearland, TX 77584	7450 Tower Street Richland Hills, TX 76118
8200 Berry Ave. Suite 100 Sacramento, CA 95828	1365 Dean Forest Rd. Savannah, GA 31405	7355 Oakley Industrial Blvd. Union City, GA 30291	
	1144 Silstar Rd. West Columbia, SC 29170	325 McGhee Rd. Winchester, VA 22603	

Website: www.mcelroymetal.com • E-mail: info@mcelroymetal.com