

Mirage and Mirage II Panel

Product Data

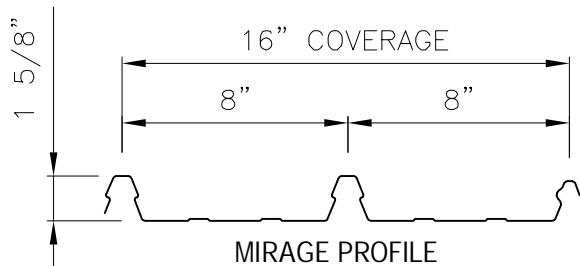

MIRAGE PROFILE
(Manufactured in Adelanto, CA)

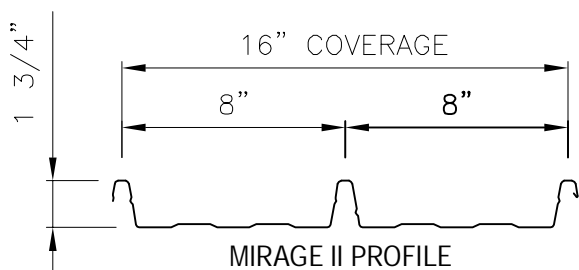

MIRAGE II PROFILE
(Manufactured in Ashburn, GA)

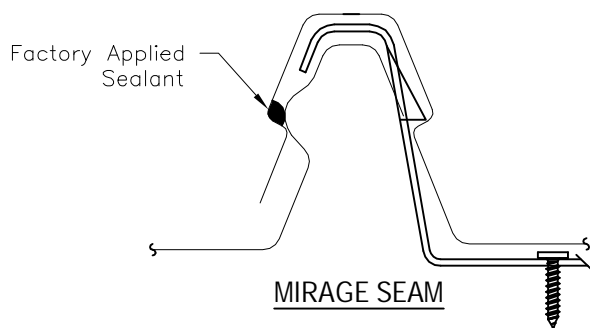

MIRAGE SEAM

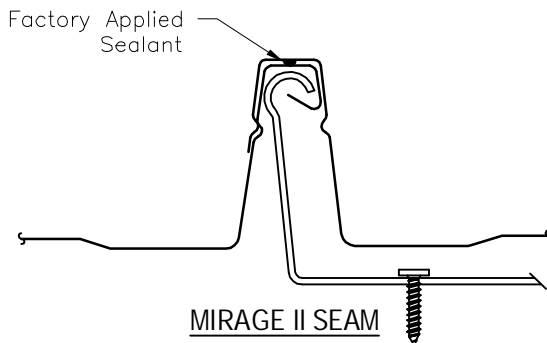

MIRAGE II SEAM

Applications

Snap Seamed roof panel used on slopes down to 1/4:12. (Factory applied sealant is required on seam (side laps) at less than 3:12 slope.) Continuous lengths up to 40'. Please inquire for longer lengths.

Substrates

Plywood, Metal Deck, Rigid Insulation/Metal Deck or Open Framing.

Material

Standard - 24 GA. ASTM A792 (50 ksi steel) AZ55 - Bare
AZ50 - Painted

Manufacturing

Roll formed in factory.

Finishes

Acrylic Coated Galvalume®
Fluoropolymer (Kynar 500® PVDF resin-based)

Pan Conditions

Ribbed
Oil canning is inherent in all metal panels and is not cause for panel rejection.

Testing *

Uplift: UL 580 Class 90 (Mirage & Mirage II)
ASTM E1592 (Mirage only)
Air & Water Infiltration: ASTM E1680, and ASTM E1646.
Fire Resistance: UL 263 & UL 790 Class A
Impact Testing: UL2218 Class 4
Florida Product Approval: Mirage - FL 1747.7 and FL 1832.9
Mirage II - FL 13647.1

IAPMO Approval: ER-0270 (Mirage only)
*Testing and Approvals are product specific. Please inquire for details. *

NOTE:

All data represented on this sheet may not be applicable to all widths and gauges. Please contact McElroy Metal for more information.

Mirage and Mirage II Panel (Continued)

Product Data

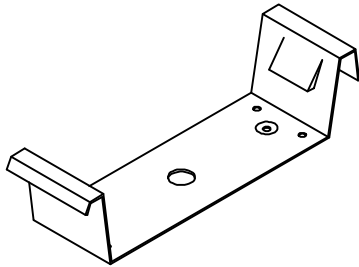

MIRAGE CLIP

16 GA. - Galvanized G90 ASTM A653 (50 ksi)

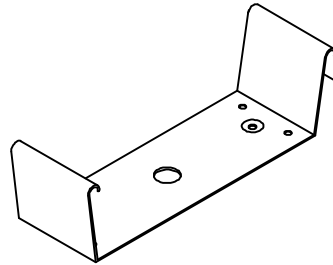

MIRAGE II CLIP

16 GA. Galvanized G90 - ASTM A653 (50 ksi)

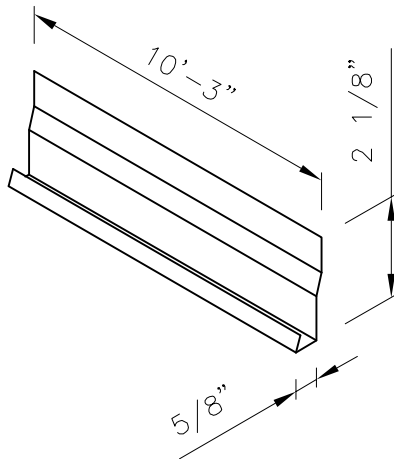

BARAGE CLEAT

24 GA. - ASTM A792 (50 ksi)

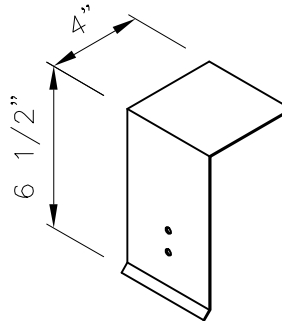

7" BARAGE CLIP

16 GA. - ASTM A653 (50 ksi)



FOAM INSIDE CLOSURE

Mirage



FOAM INSIDE CLOSURE

Mirage II



FOAM OUTSIDE CLOSURE

Mirage



FOAM OUTSIDE CLOSURE

Mirage II