

MASTERLOK-FS MASTERLOK-90

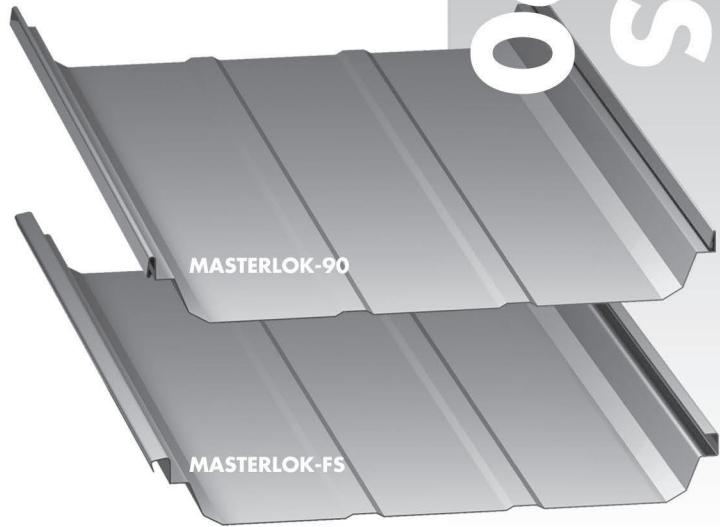

Panel/Trim /Accessories



MASTERLOK-90/FS

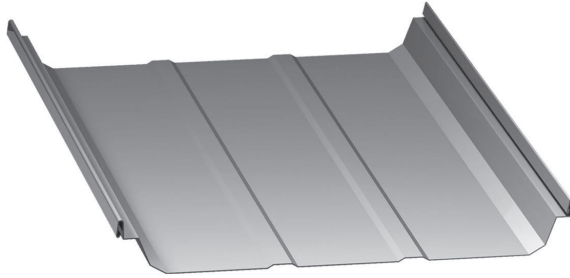

MasterLok-90

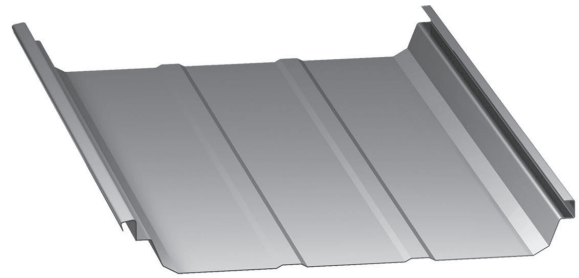

MasterLok-FS

MASTERLOK-90 PANEL

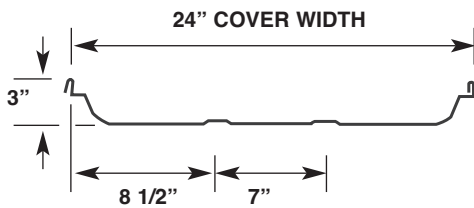

MASTERLOK-FS PANEL

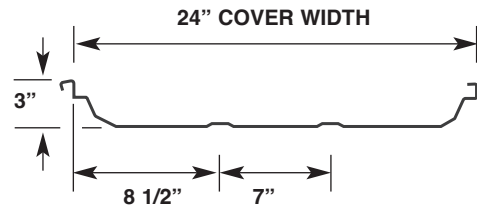

MasterLok-90 / MasterLok-FS Load Tables and Section Properties

Load tables and section properties for MasterLok-90 and MasterLok-FS can be found online at www.mcelroymetal.com. Please contact the **McElroy Engineering Department at 1-800-950-9082** for additional information.

Details:

- Factory applied sealant in seam to improve weather-tightness
- MasterLok-90 minimum slope: 1/4:12
- MasterLok-FS minimum slope: 1/4:12
- Can be installed over solid deck or open framing
- MasterLok-FS is a mechanically seamed profile
- MasterLok-90 also available with MoistureLok

Panel Options:

- Panel width: 24"
- Coating:
 - Kynar 500® (PVDF)
- Substrate:
 - Standard 24 GA Galvalume®
 - Optional 22 GA Galvalume

Notes:

- Oil canning is inherent in all metal panels and is not cause for panel rejection.
- Please contact a McElroy representative for specific pricing, lead times, special colors or gauges that may not be on a McElroy Metal color chart.
- Contents in this manual are subject to change without notice. To confirm this book is the most current copy, please visit McElroy's website at www.mcelroymetal.com.

MASTERLOK-90/FS

TRIM

24 GA

Simple Eave Trim*
MLSE

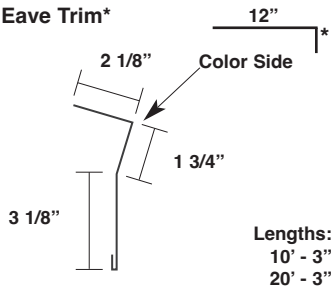

Sculptured Eave Trim*
MLSCE

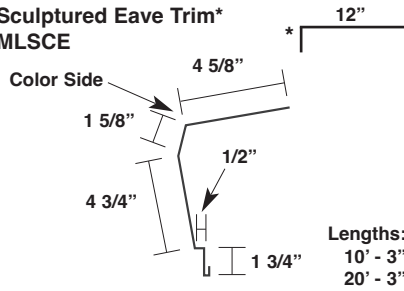

Termination Trim
MLVT

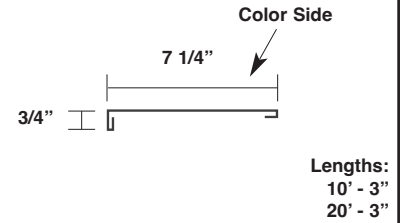

Rake Trim
MLRT

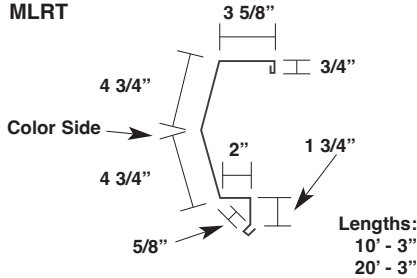

Rake Slide
MLRS

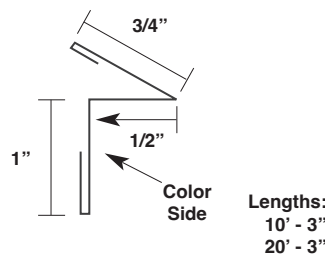

Rake End
ML-RE

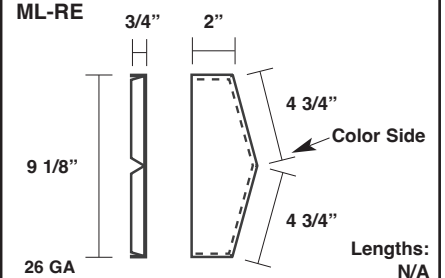

Rake Tie-In Trim

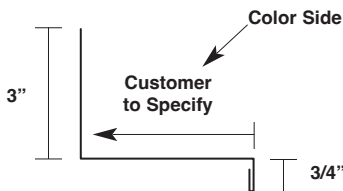

Alternate Rake Tie-In Trim

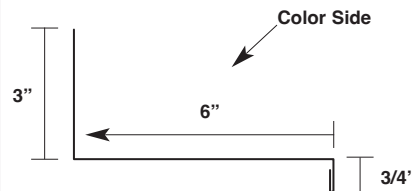

High Side Eave Trim
(Up to 2:12 Pitch)
MLHS1

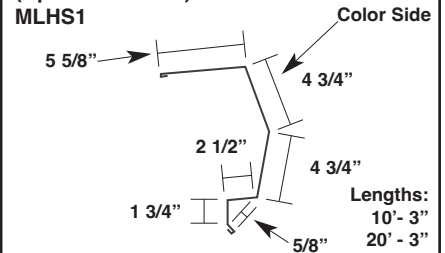

High Side Eave Trim
(Over 2:12 to 4:12 Pitch)
MLHS4

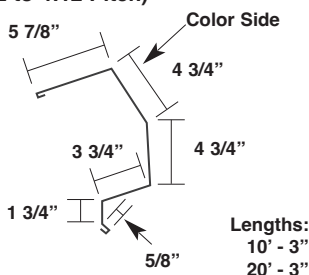

Fixed High Side Tie-In*
MLFXHST

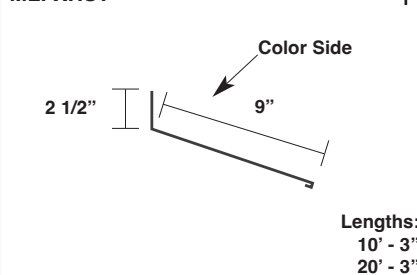

Floating High Side Tie-In*
MLFLHST

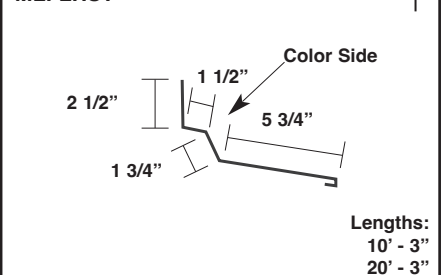

Fixed Ridge Flashing*
(Up to 4:12 Pitch)
MFXR1

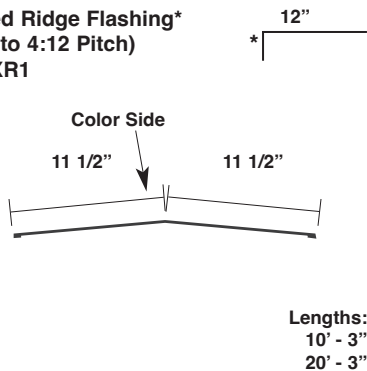

Floating Ridge Flashing*
(Up to 4:12)
MFLR4

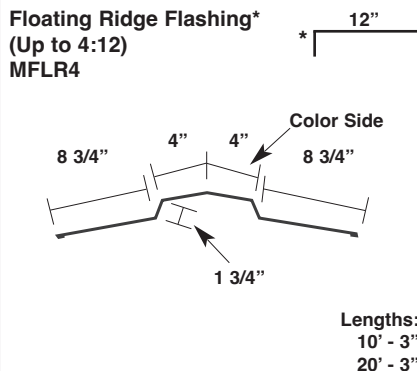

Fixed Peak Box
(Up to 2:12 Pitch)
MLFXPB1

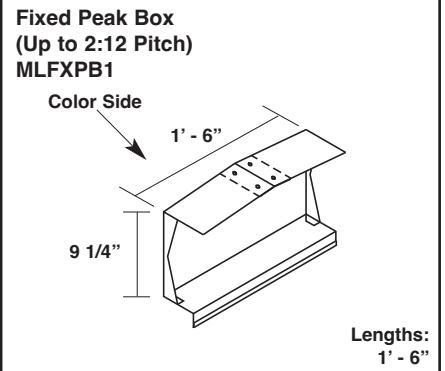

*specify roof pitch

MASTERLOK-90/FS

TRIM

24 GA

**Fixed Peak Box
(Over 2:12 to 4:12 Pitch)
MLFXPB4**

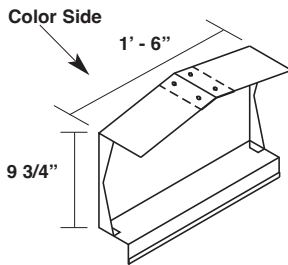

Lengths:
1' - 6"

**Floating Peak Box
(Up to 2:12 Pitch)
MLFLPB1**

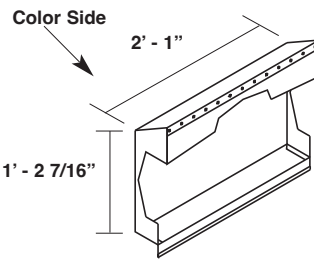

Lengths:
2' - 1"

**Floating Peak Box
(Over 2:12 to 4:12 Pitch)
MLFLPB4**

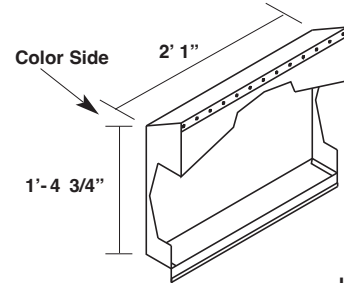

Lengths:
2' - 1"

**Gutter
(Up to 2:12 Pitch)
MLG1**

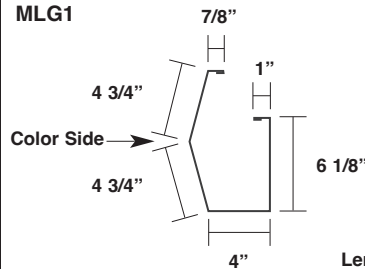

Lengths:
10' - 3"
20' - 3"

**Gutter
(Over 2:12 to 4:12 Pitch)
MLG4**

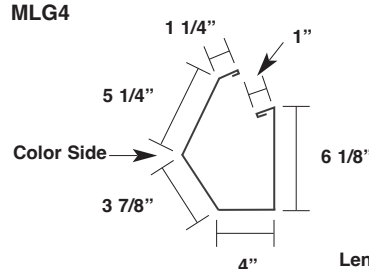

Lengths:
10' - 3"
20' - 3"

**Gutter Strap
ML-GS**

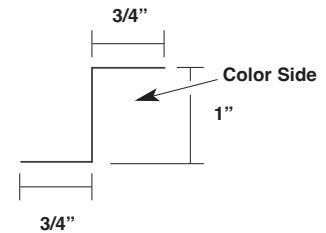

Lengths:
0' - 6"

**Gutter End Cap
(Up to 2:12 Pitch)
MLGE1**

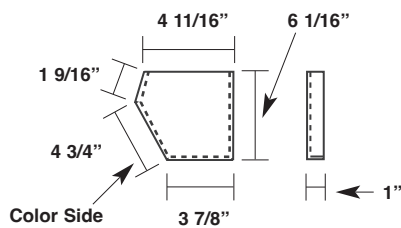

26 GA

Lengths:
N/A

**Gutter End Cap
(Over 2:12 to 4:12 Pitch)
MLGE4**

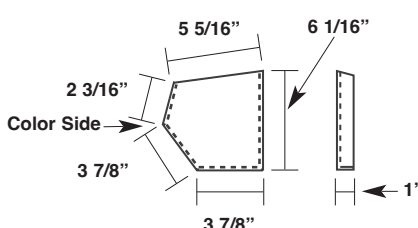

26 GA

Lengths:
N/A

**Outside Corner Box for Standard Gutter
Up to 2:12 Pitch**

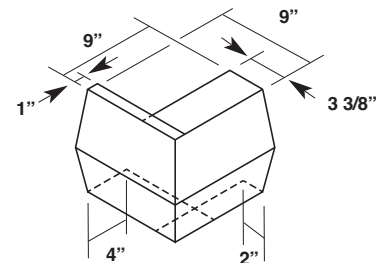

26 GA
(Right Hand Shown
- Left Hand Opposite)

Lengths:
N/A

**Outside Corner Box for Standard Gutter
2:12 to 4:12 pitch**

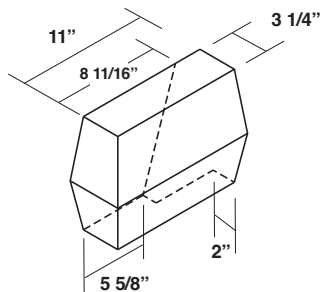

26 GA
(Right Hand Shown
- Left Hand Opposite)

Lengths:
N/A

**Gutter Corner Box for Sculptured Eave
(Up to 4:12 Pitch)**

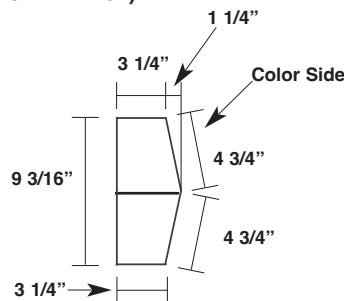

26 GA
(Right Hand Shown
- Left Hand Opposite)

Lengths:
N/A

**High Eave Corner Box
(Right Hand Shown-Left Hand Opposite)**

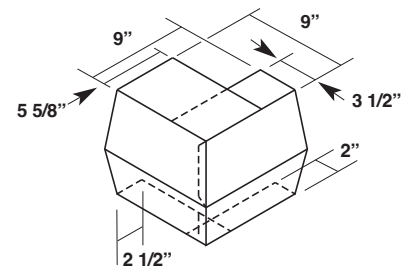

26 GA

Lengths:
N/A

MASTERLOK-90/FS

26 GA

**Cinch Angle
ML-CA**

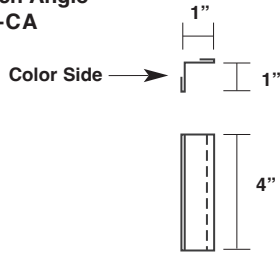

26 Ga.

Lengths:
0' - 4"

**High-Low Tie-In Trim*
MLHL**

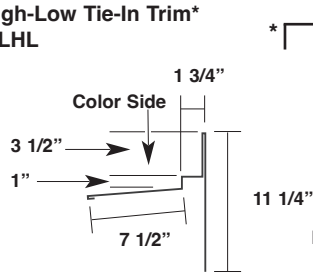

Lengths:
10' - 3"
20' - 3"

**Zee Flashing
ML3ZF**

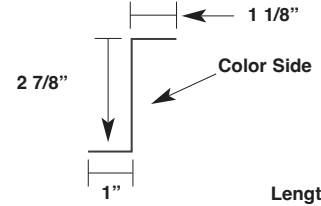

Lengths:
10' - 3"

**Insulation Angle Trim
MLIA**

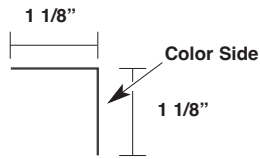

Lengths:
10' - 3"

**Insulation Zee Trim
MLIZ**

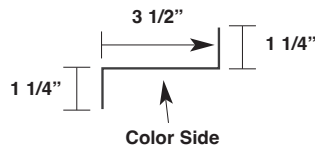

Lengths:
2' - 0"

**Aluminum Downspout Outlet Box
BBPOUT**

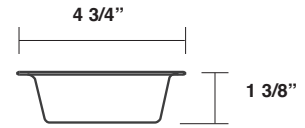

Lengths:
N/A

**3" x 4" Downspout
BBPDS**

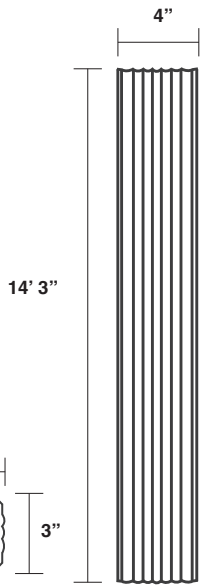

Lengths:
14' - 3"

**Downspout Strap
BBPDSS**

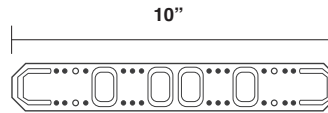

Lengths:
10"

**3" x 4" Downspout Elbow
A-Style
BBPELA**

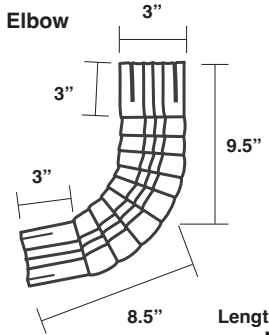

Lengths:
N/A

**Lock-Seam Downspout - Corner
(Right Hand Corner Shown)**

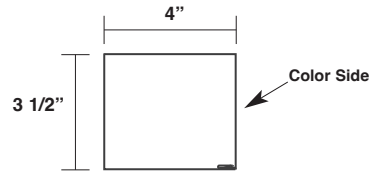

Please specify left or right hand corner

Lock-Seam Downspout - Center

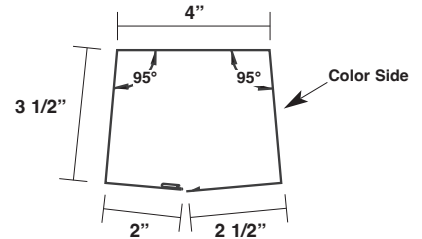

**Lock-Seam Downspout Outlet -
Standard**

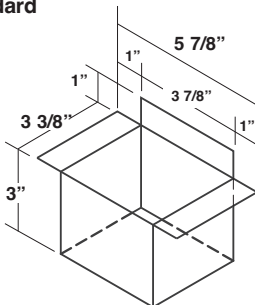

Lock-Seam Downspout Strap

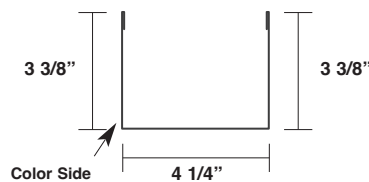

MASTERLOK-90/FS

ACCESSORIES

1/4 - 14 x 1 1/4"
TEK2
Self Driller
W/O Washer - Plain
Item #: 10969

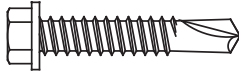

#12 - 24 x 1 1/4"
TEK 4.5
W/O Washer - Plain
Item #: 10979

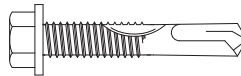

1/4 - 14 x 1 1/4"
Shoulder TEK2 3/8
HWH W/O Washer - Plain
Item #: 10975

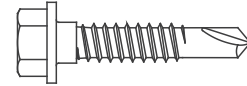

1/4 - 14 x 1 1/4"
TEK2 ZAC
(Part # varies by color)

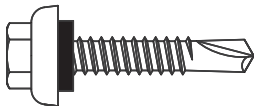

1/4 - 14 x 7/8"
LAPTEK ZAC
Self Driller
(Part # varies by color)

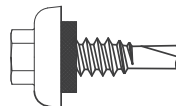

#14-10 Dekfast Pan Head
(Length varies by application)

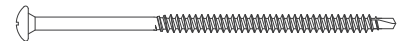

43D Pop Rivet
(Part # varies by color.)



ML-90 Utility Fixed Clip
Item #: 10919

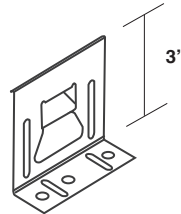

ML-90 Low Fixed Clip
Item #: 10921

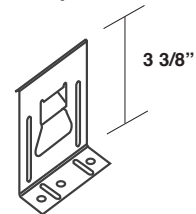

ML-90 High Fixed Clip
Item #: 10922

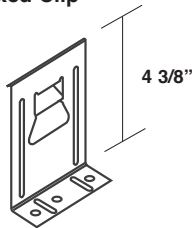

ML-90 Utility Floating Clip
Item #: 10920

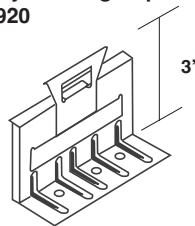

ML-90 Low Floating Clip
Item #: 10923

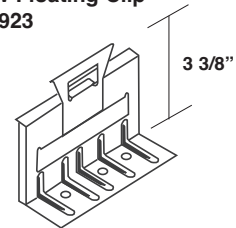

ML-90 High Floating Clip
Item #: 10924

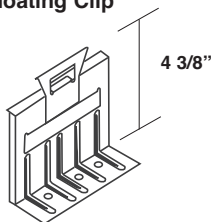

ML-FS Low Floating Clip
Item #: 10211

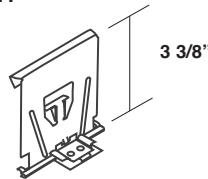

ML-FS High Floating Clip
Item #: 10212

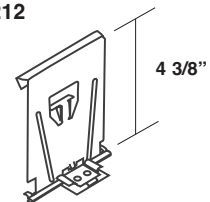

ML-FS 5" Tall Clip
Item #: 227329

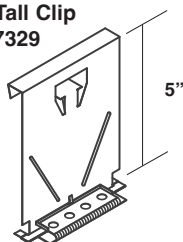

Utility Eave Plate
Item #: 17477

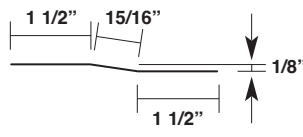

Lengths:
10'

Low Eave Plate
Item #: 10936

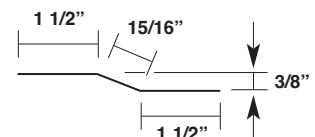

Lengths:
10'

MASTERLOK-90/FS

ACCESSORIES

High Eave Plate
 Item #: Galvanized: 211274
 Red Primed: 237215

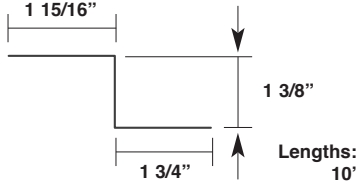

Utility Fixed Rake Support Angle
 Item #: 10' - 11213
 Item #: 20' - 11196

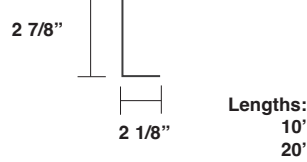

Low Fixed Rake Support Angle
 Item #: 10' - 11005
 Item #: 20' - 10941

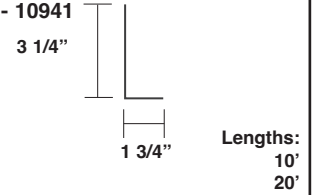

High Fixed Rake Support Angle
 Item #: 10' - 11002
 Item #: 20' - 10943

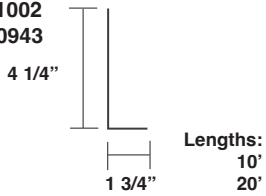

Utility Floating Rake Support Angle
 Item #: 10942

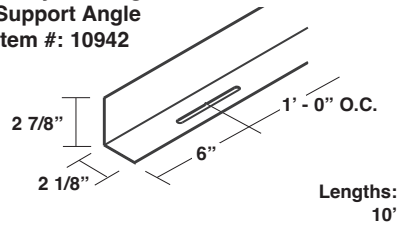

Low Floating Rake Support Angle
 Item #: 10944

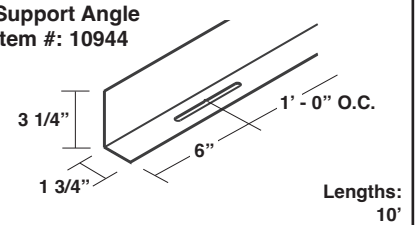

High Floating Rake Support Angle
 Item #: 10946

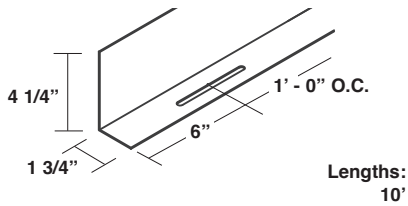

MLFS Tall Floating Rake Support Angle
 Item #: 232319

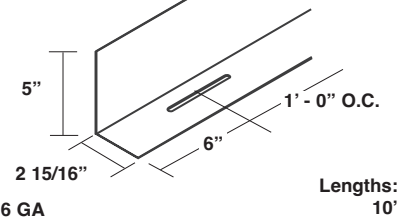

MLFS Tall Eave Plate
 Item #: 232237

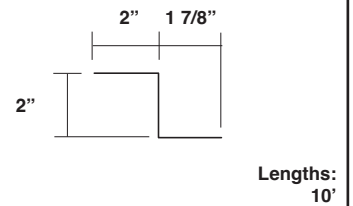

MLFS Tall Floating Rake Plate
 Item #: 232318

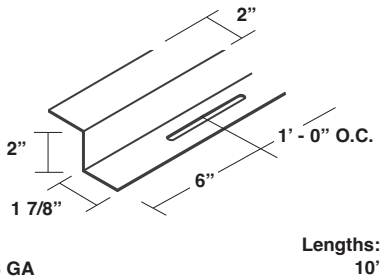

Floating Eave Plate 2" Stdoff
 Item #: 232440

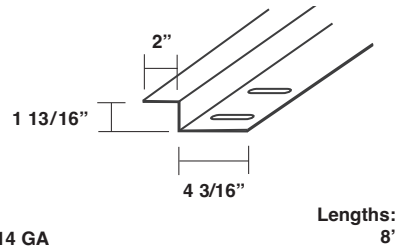

Bearing Plate
 Primed Item #: 94599
 Galvanized Item #: 203541

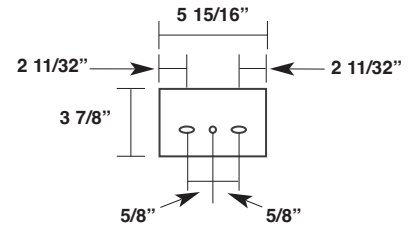

Modified Back-Up Plate for 18" and 24" Utility Systems
 Item # 18": 11206
 Item # 24": 10948

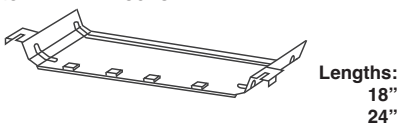

Standard Back-Up Plate for 24" Wide Panels
 Item #: 10949

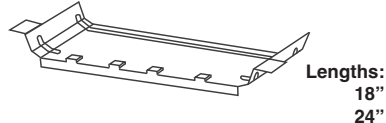

Standard Back-Up Plate for 18" Wide Panels
 Item #: 10950

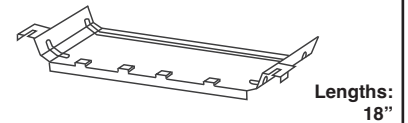

Inside Closure - Metal
 (Available in bare only. Item #10911)



Inside Closure - Rubber
 Item #: 10957



Outside Closure
 (Item # varies by color)

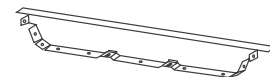

MASTERLOK-90/FS

ACCESSORIES

ML-90 Cinch Strap
(Part # varies by color)

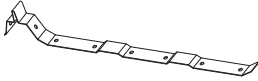

ML-FS Cinch Strap
(Part # varies by color)

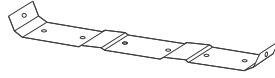

Butyl Tape Sealant - Double Bead
3/16" x 7/8" x 40'
Item #: 95460

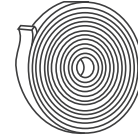

Butyl Tape Sealant
1 1/2" x 1/8" x 30'
Item #: 10959

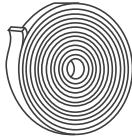

Butyl Tape Sealant
3/32" x 1" x 45'
Item #: 95335

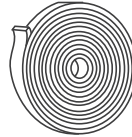

Strip Tape
3/4" x 1 3/8" x 7/32" x 4"
Item #: 95365

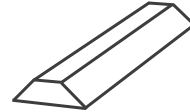

Titebond Caulk Sealant
(Part # varies by color)



Sikalastomer Butyl Tube Sealant
Item #: 95342



Thermal Spacer
3/8" x 3" x 23 7/8" Item #: 11006
5/8" x 3" x 23 7/8" Item #: 11008
1" x 3" x 23 7/8" Item #: 10960
1 3/8" x 3" x 23 7/8" Item #: 10961

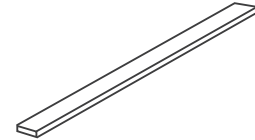

Touch-Up Paint Pen
(Part # Varies by Color)



ML90 Seam Snapping Tool
Item #: 10967

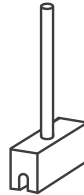

Unseaming Tool
(ML-90 Only)
Item #: 10966

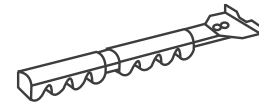

Notes:

Blank area for notes.



MASTERLOK-90/FS

NOTES:



☆ MANUFACTURING LOCATIONS ● SERVICE CENTERS ★ MANUFACTURING AND SERVICE CENTER



CORPORATE OFFICE
1500 HAMILTON RD.
BOSSIER CITY, LA 71111

MANUFACTURING LOCATIONS

ADELANTO, CA	ASHBURN, GA	BOSSIER CITY, LA	CLINTON, IL	DIAMOND, MO
HOUSTON, TX	LEWISPORT, KY	LOCKHART, TX	MARSHALL, MI	MAUSTON, WI
MERKEL, TX	PEACHTREE CITY, GA	SUNNYVALE, TX	WINCHESTER, VA	

MCELROY METAL
SERVICE
CENTER
EMPLOYEE OWNED

17031 Koala Road Adelanto, CA 92301	5215 Leo St. Alexandria, LA 71301	1007 Wilso Dr, Baltimore, MD 21223	1500 Hamilton Rd. Bossier City, LA 71111
3052 Yadkin Road Chesapeake, VA 23323	9476 Meadowbrook Rd. Clinton, IL 61727	3215 Highway 59 Diamond, MO 64840	390 N. Valley Dell Dr. Fenton, MO 63026
409 Lovejoy Road Ft. Walton Beach, FL 32548	3014 Lincoln Court Garland, TX 75041	1440 Aldine Bender Road Houston, TX 77032	221 Benelli Drive Hutto, TX 78634
10504 E. 59th Street Indianapolis, IN 46236	32 Industrial Circle Lancaster, PA 17601	9435 US Hwy. 60 W. Lewisport, KY 42351	2701 Cahill Street Lockhart, TX 78644
1020 Veterans Street Mauston, WI 53948	5123 Terminal Dr. McFarland, WI 53558	514 Cave Road Nashville, TN 37210	8304 Hwy. 70 E. North Little Rock, AR 72117
613 North Bierdeman Rd. Pearl, MS 39208	8511 Industrial Drive Pearland, TX 77584	2755 Hwy 60 Pendergrass, GA 30567	7450 Tower Street Richland Hills, TX 76118
8200 Berry Ave. Suite 100 Sacramento, CA 95828	1365 Dean Forest Rd. Savannah, GA 31405	7355 Oakley Industrial Blvd. Union City, GA 30291	1144 Silstar Rd. West Columbia, SC 29170
325 McGhee Rd. Winchester, VA 22603			

Website: www.mcelroymetal.com • E-mail: info@mcelroymetal.com