

MATRIX MESA MAX-RIB

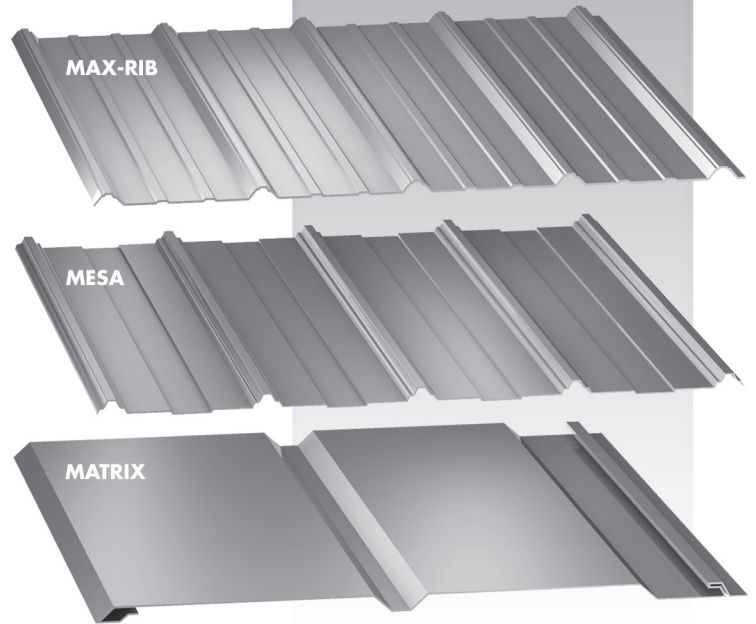

Panel / Trim / Accessories



MAX-RIB

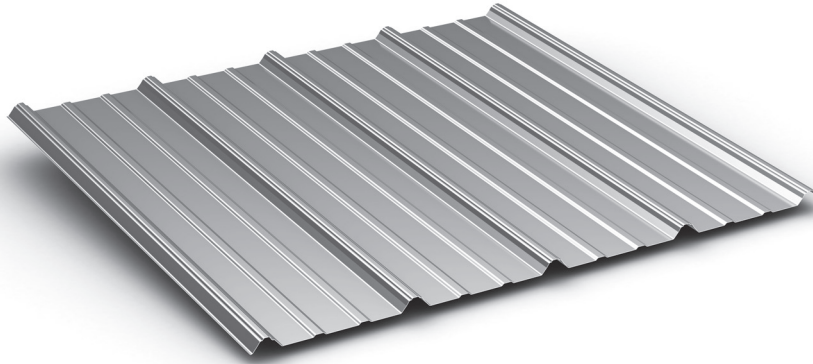

Max-Rib

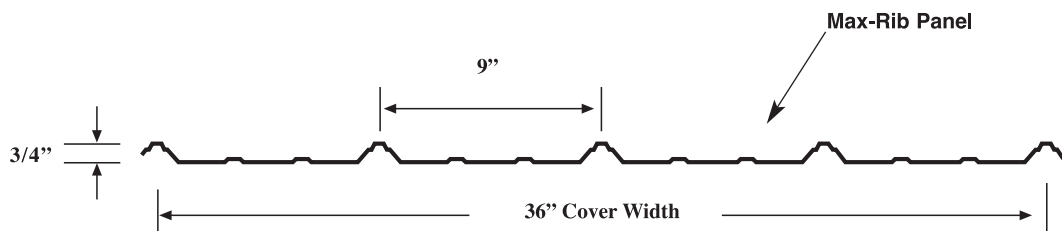

Max-Rib Load Tables and Section Properties

For any available Testing Data, Section Properties, or Load Tables, please visit www.mcelroymetal.com. For additional information, please contact the **McElroy Engineering Department at 1-800-950-9082**.

Details:

- Minimum slope: 1:12 (with sealant)
- Minimum slope: 3:12 (without sealant)
- Max-Rib also available with MoistureLok

- Oil canning is a natural occurrence in metal panels and is not a cause for panel rejection

Panel Options:

- Coating:
 - Kynar 500® (PVDF)
 - Silicone Modified Polyester (SMP)

- Substrate:
 - Standard 29 and 26 GA Galvalume®
 - Standard 29 GA G100 Galvanized

MESA

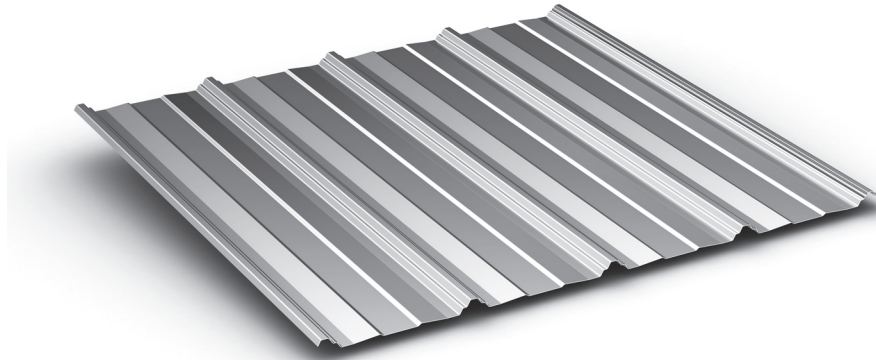

Mesa

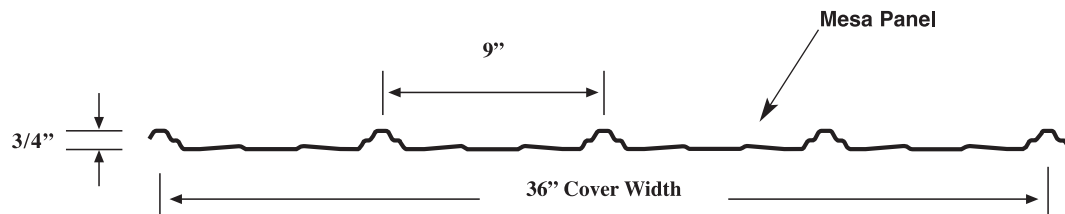

Mesa Load Tables and Section Properties

For any available Testing Data, Section Properties, or Load Tables, please visit www.mcelroymetal.com. For additional information, please contact the **McElroy Engineering Department at 1-800-950-9082**.

Details:

- Minimum slope: 1:12 (with sealant)
- Minimum slope: 3:12 (without sealant)
- Patent and copyright protected
- Nearly invisible lap
- Ideal for post frame structures and residential roofing
- Mesa is also available with MoistureLok

- Oil canning is a natural occurrence in metal panels and is not a cause for panel rejection

Panel Options:

- Coating:
 - Kynar 500® (PVDF)

- Substrate:
 - Standard 26 and 29 GA Galvalume®

MATRIX 12"

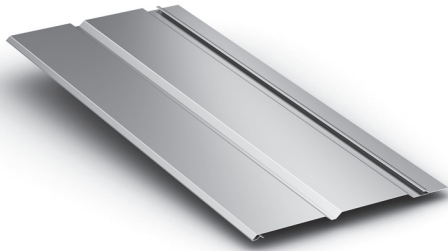

Matrix 12" Non-Vented

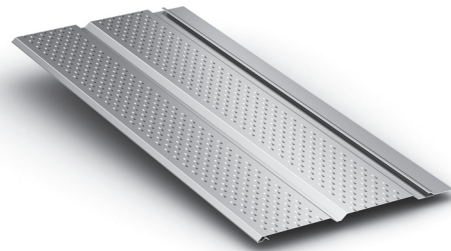

Matrix 12" Vented 10% Net Free Area



Details:

- Stocked lengths: 11.5" and 23.5"
- 10% net free area with vented surface
- Matrix 12" is produced in Lewisport, KY
- Oil canning is a natural occurrence in metal panels and is not a cause for panel rejection

Panel Options:

- Panel width: 12" only
- Panel configurations: non-vented or vented
- Coating:
 - Acrylic Coated Galvalume® 24 GA & 29 GA
 - Kynar 500® (PVDF) 24 GA & 29 GA
- Substrate:
 - Standard - 29 GA & 24 GA

MATRIX 12" TRIM

29 GA

Matrix F and J x 1/2" MTFJ12

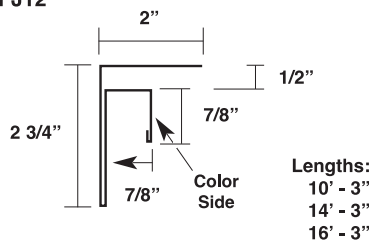

Matrix F and J x 7/16" MTFJ716

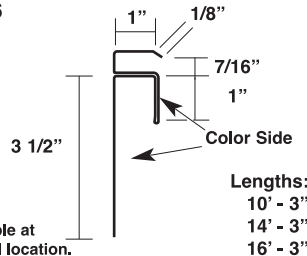

Matrix Soffit J MTSJ

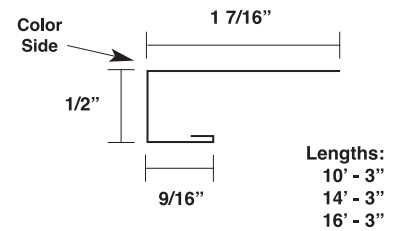

Matrix F x 1/2" MTF

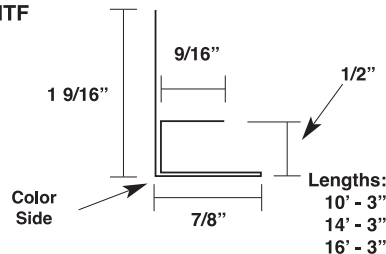

Angle Trim 7/8" x 2" MTA2

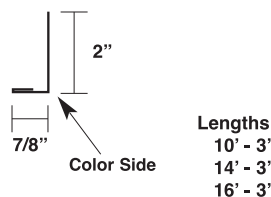

Angle Trim 7/8" x 4" MTA4

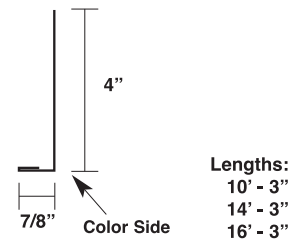

MATRIX 12"

TRIM MATRIX 12" 29 GA

<p>Angle trim - 7/8 x 6" MTA6</p> <p>Lengths: 10' - 3" 14' - 3" 16' - 3"</p>	<p>Outside Angle Trim P-OA</p> <p>Lengths: 10' - 3" 14' - 3" 16' - 3"</p>	<p>Inside Angle Trim P-IA</p> <p>Lengths: 10' - 3" 14' - 3" 16' - 3"</p>
<p>Base & Drip Trim P-DF</p> <p>Lengths: 10' - 3" 14' - 3" 16' - 3"</p>	<p>Perimeter Cleat MTPC</p> <p>Lengths: 10' - 3" 14' - 3" 16' - 3"</p>	

MATRIX 12"

ACCESSORIES

<p>#10 - 16 x 1" TEK2 Pancake Head Self-Driller Item #: 36117001</p>	<p>#10 - 12 x 1" Type A Pancake Head Woodgrip Item #: 36116001</p>	
---	---	--

Notes:

MATRIX 16"

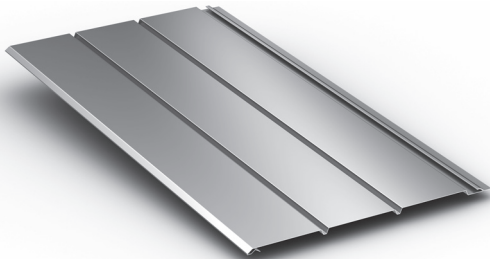

Matrix 16" Non-Vented

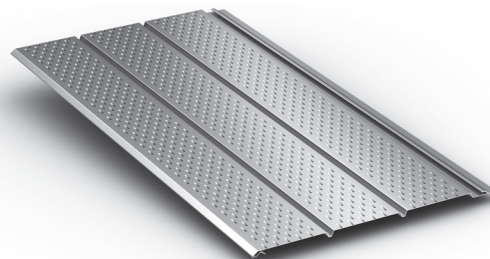

Matrix 16" Vented 10% Net Free Area

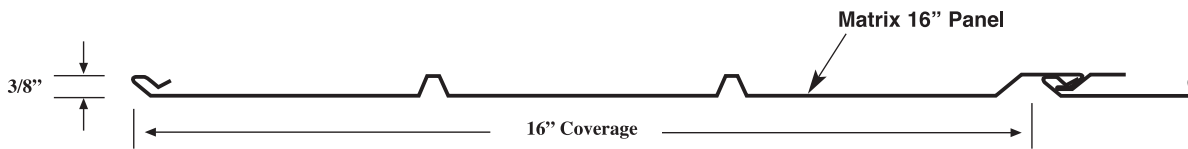

Details:

- Stocked lengths: 11.5" and 23.5"
- 10% net free area with vented surface
- Matrix 16" is produced in Marshall, MI

- Oil canning is a natural occurrence in metal panels and is not a cause for panel rejection

Panel Options:

- Panel width: 16" only
- Panel configurations: non-vented or vented

- Coating:
 - Acrylic Coated Galvalume® 26 GA & 29 GA
 - Kynar 500® (PVDF) 26 GA
 - Siliconized Polyester 29 GA

- Substrate:
 - Standard 26 GA & 29 GA

MATRIX 16" TRIM

29 GA

Matrix F and J x 1/2"
MTFJ12

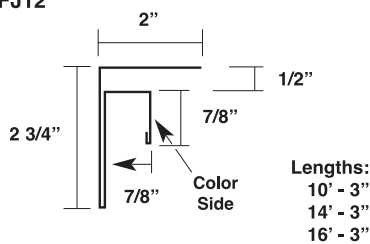

Matrix F and J x 7/16"
MTFJ716

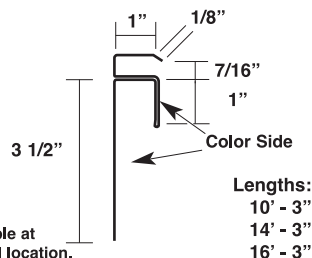

Matrix Soffit J
MTSJ

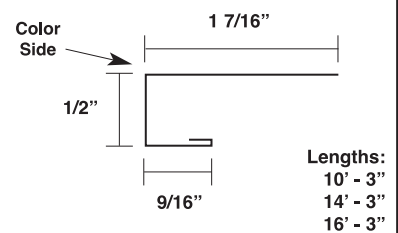

Matrix F x 1/2"
MTF

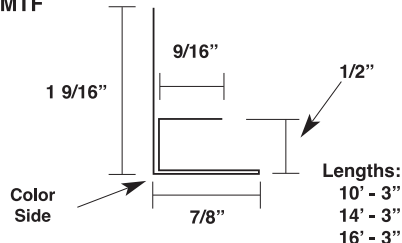

Angle Trim 7/8" x 2"
MTA2

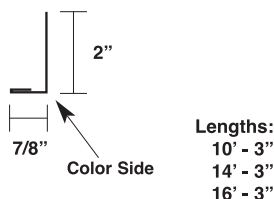

Angle Trim 7/8" x 4"
MTA4

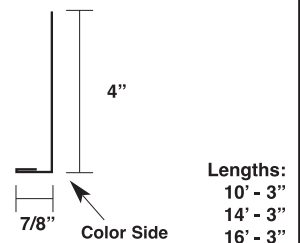

MATRIX 16"

TRIM MATRIX 16"

29 GA

Angle trim - 7/8 x 6"
MTA6

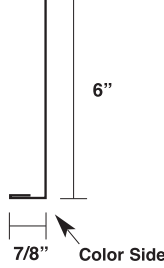

Lengths:
10' - 3"
14' - 3"
16' - 3"

Outside Angle Trim
P-OA

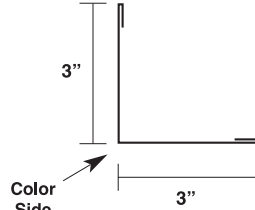

Lengths:
10' - 3"
14' - 3"
16' - 3"

Inside Angle Trim
P-IA

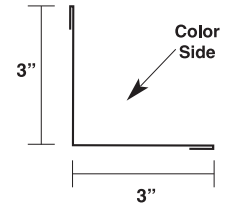

Lengths:
10' - 3"
14' - 3"
16' - 3"

Base Drip
P-DF

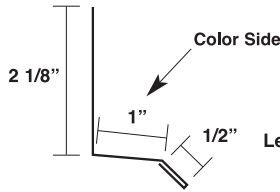

Lengths:
10' - 3"
14' - 3"
16' - 3"

Perimeter Cleat
MTPC

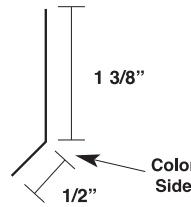

Lengths:
10' - 3"
14' - 3"
16' - 3"

MATRIX 16"

ACCESSORIES

#10 - 16 x 1" TEK2
Pancake Head
Self-Driller
Item #: 36117001

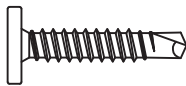

#10 - 12 x 1" Type A
Pancake Head
Woodgrip
Item #: 36116001

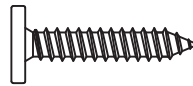

Notes:

MAX-RIB / MESA

TRIM POST FRAME

29 GA

**Base and Drip Flashing
(P-DF)**

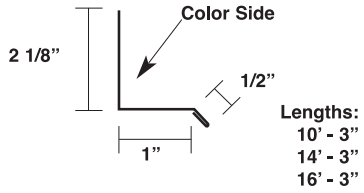

**Base Flashing - A
(P-BF-A)**

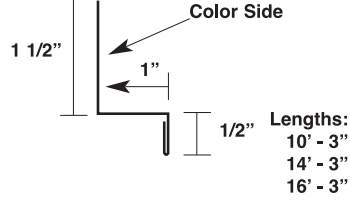

**Base Flashing - B
(P-BF-B)**

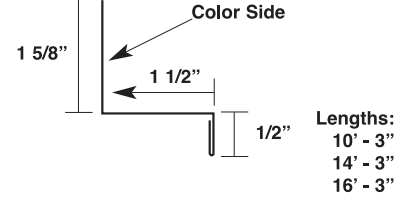

**Rodent Guard
(P-RG-71)**

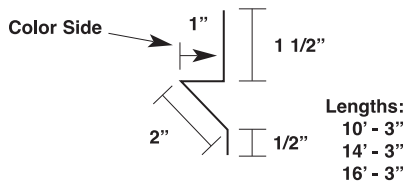

**Rodent Guard
(P-RG-72)**

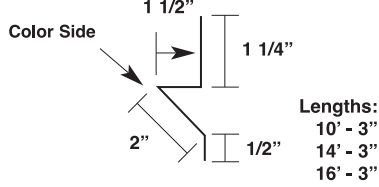

**Square Base
(P-SQB)**

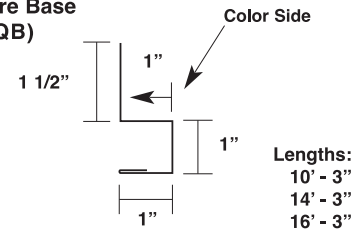

**Zee Flashing
(P-ZF)**

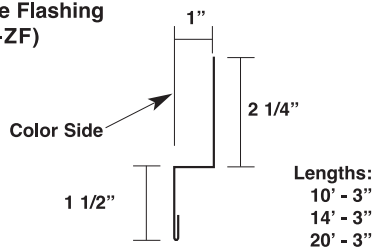

**Mini-Outside Corner
(P-MOC)**

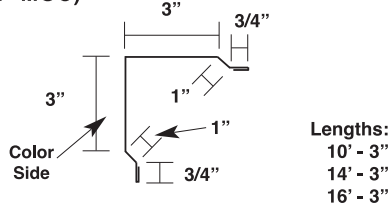

**Outside Corner
(P-OC)**

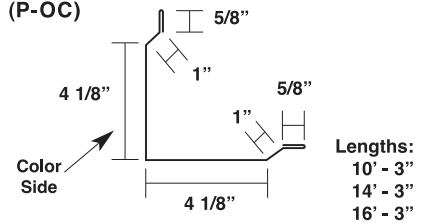

**Inside Corner
(P-IC)**

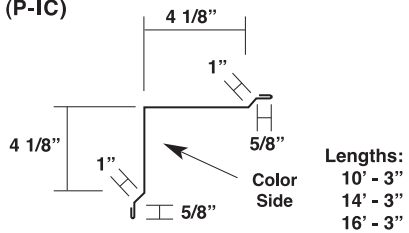

**Outside Angle
(P-OA)**

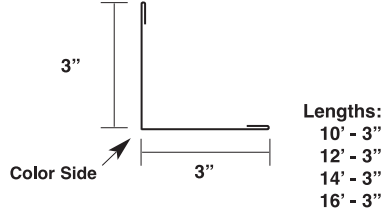

**Inside Angle
(P-IA)**

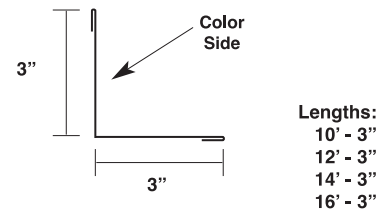

***Angle (P-A)**

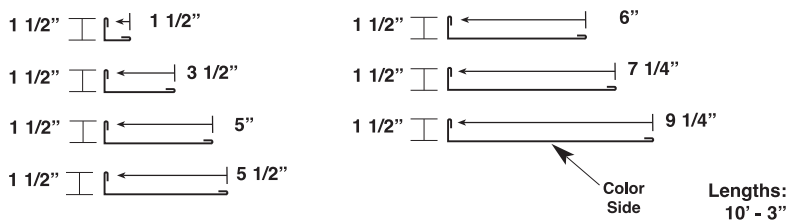

**J - Channel
(P-JC)**

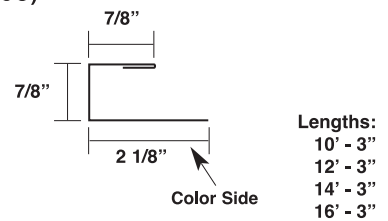

**Wide J
(P-WJ)**

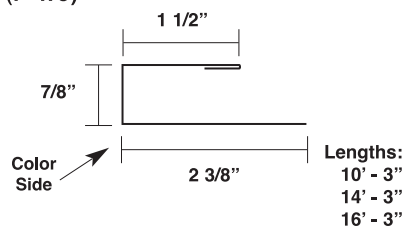

**F x 7/8"
(P-F-7/8)**

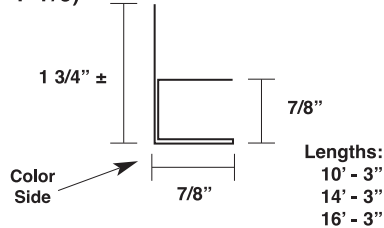

**F and J x 3/4"
(P-FJ34)**

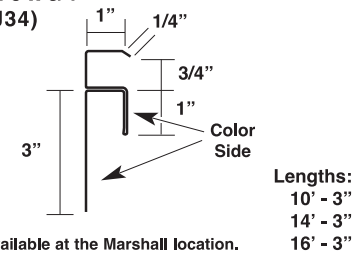

Only available at the Marshall location.

MAX-RIB / MESA

TRIM POST FRAME

29 GA

F and J x 1 1/4"
(P-FJ114)

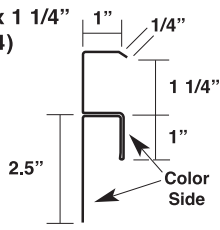

Lengths:
10' - 3"
14' - 3"
16' - 3"

Only available at the Marshall location.

F and J x 7/8"
(P-FJ78)

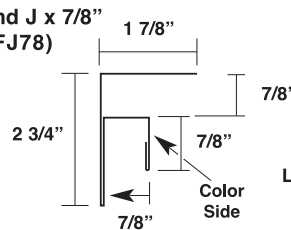

Lengths:
10' - 3"
14' - 3"
16' - 3"

F and J x 1 3/8"
(P-FJ138)

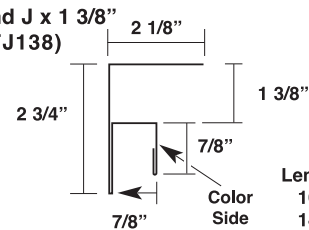

Lengths:
10' - 3"
14' - 3"
16' - 3"

Door & Edge Cap
(P-DEC)

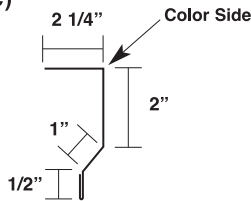

Lengths:
10' - 3"
14' - 3"
16' - 3"

Overhead Door Drip 4 1/2"
(P-ODP-4 1/2)

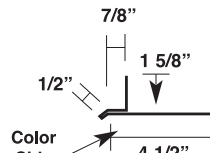

Lengths:
10' - 3"
14' - 3"
16' - 3"

Overhead Door Drip 6"
(P-ODP-6)

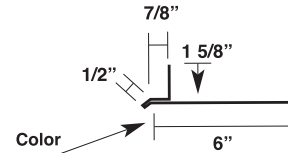

Lengths:
10' - 3"
14' - 3"
16' - 3"

Overhead Door Drip 6 1/2"
(P-ODP-6 1/2)

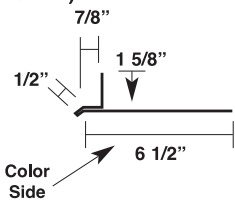

Lengths:
10' - 3"
14' - 3"
16' - 3"

Overhead Door Drip 8"
(P-ODP-8)

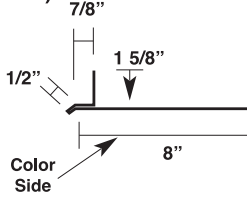

Lengths:
10' - 3"
14' - 3"
16' - 3"

Overhead Door Drip 8 7/8"
(P-ODP-8 7/8)

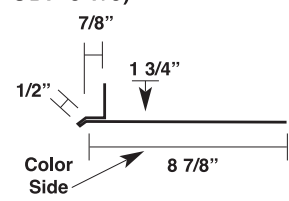

Lengths:
10' - 3"
14' - 3"
16' - 3"

Overhead Door Flashing 4 1/2"
(P-JF-B-4 1/2)

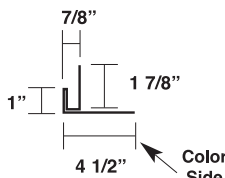

Lengths:
10' - 3"
14' - 3"
16' - 3"

Overhead Door Flashing 6"
(P-JF-B-6)

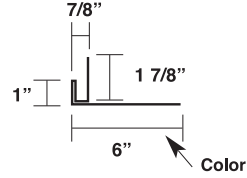

Lengths:
10' - 3"
14' - 3"
16' - 3"

Overhead Door Flashing 6 1/2"
(P-JF-B-6 1/2)

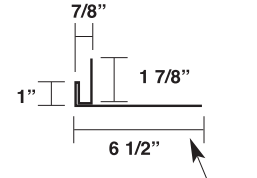

Lengths:
10' - 3"
14' - 3"
16' - 3"

Overhead Door Flashing 8"
(P-JF-B-8)

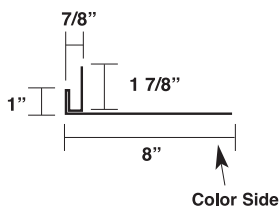

Lengths:
10' - 3"
14' - 3"
16' - 3"

Overhead Door Flashing 8 7/8"
(P-JF-B-8 7/8)

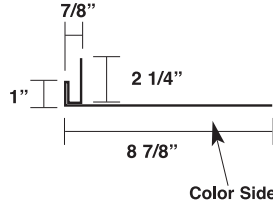

Lengths:
10' - 3"
14' - 3"
16' - 3"

Walk Door (P-DWT)
and Window Trim

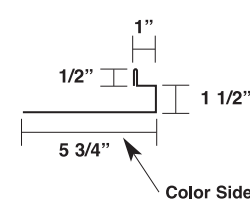

Lengths:
10' - 3"
14' - 3"
16' - 3"

Overhead Door Flashing-A
(P-JF-A)

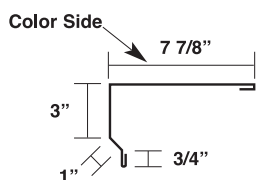

Lengths:
10' - 3"
14' - 3"
16' - 3"

Corner Siding
Door Jamb 6"
(P-CSD-6)

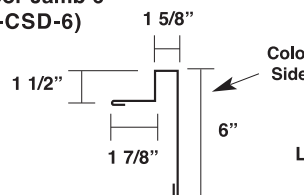

Lengths:
10' - 3"
14' - 3"
16' - 3"

Corner Sliding
Door Jamb 7 1/4"
(P-CSD-7 1/4)

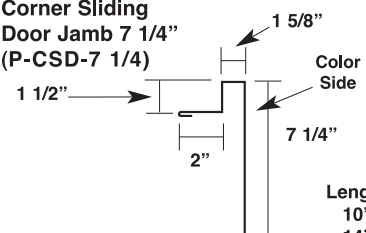

Lengths:
10' - 3"
14' - 3"
16' - 3"

MAX-RIB / MESA

TRIM POST FRAME

29 GA

**Corner Sliding
Door Jamb 9 1/4"**
(P-CSD-9 1/4)

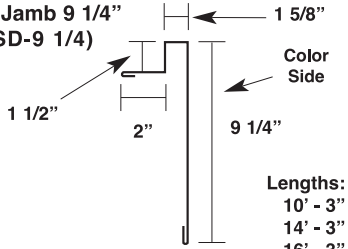

Color Side
Lengths:
10' - 3"
14' - 3"
16' - 3"

**Sliding Door Jamb
(P-SDJ)**

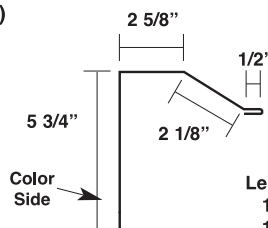

Color Side
Lengths:
10' - 3"
14' - 3"
16' - 3"

**Door Track Cover
(Face Mount) (National-A)**
(P-DTC-NA)

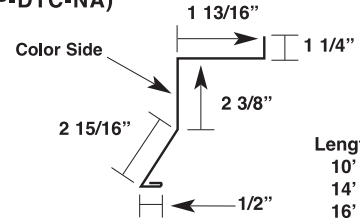

Color Side
Lengths:
10' - 3"
14' - 3"
16' - 3"

**Door Track Cover
(Top Mount) (National-B)**
(P-DTC-NB)

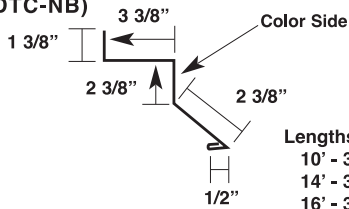

Color Side
Lengths:
10' - 3"
14' - 3"
16' - 3"

**Door Track Cover
(Cannonball Facemount)**
(P-DTC-CB)

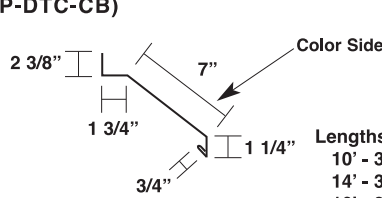

Color Side
Lengths:
10' - 3"
14' - 3"
16' - 3"

**Door Track Cover
(Cannonball Top Mount)**
(P-DTC-CBTM)

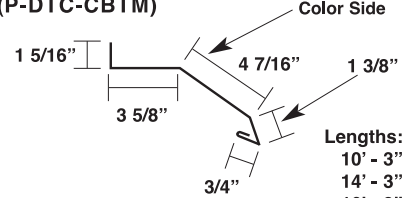

Color Side
Lengths:
10' - 3"
14' - 3"
16' - 3"

**Double Door Track Cover Cannonball
(P-DDTC-CBDT)**

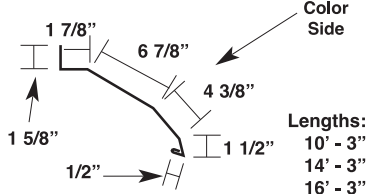

Color Side
Lengths:
10' - 3"
14' - 3"
16' - 3"

**Soffit Flashing x 3
(P-SF3)**

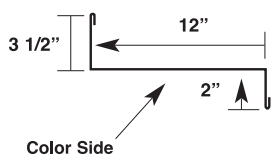

Color Side
Lengths:
10' - 3"
14' - 3"
16' - 3"

**Soffit Flashing x 5
(P-SF5)**

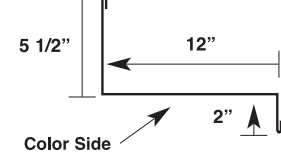

Color Side
Lengths:
10' - 3"
14' - 3"
16' - 3"

**Soffit Flashing x 7
(P-SF7)**

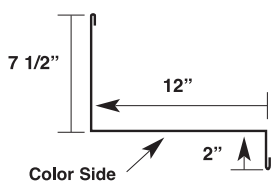

Color Side
Lengths:
10' - 3"
14' - 3"
16' - 3"

**Valley Trim*
(P-VF)**

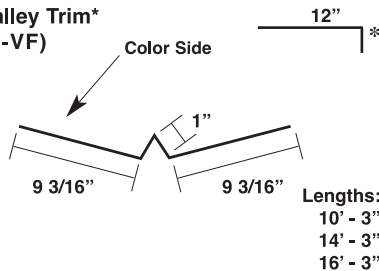

Color Side
Lengths:
10' - 3"
14' - 3"
16' - 3"

**Eave Flashing*
(P-EF)***

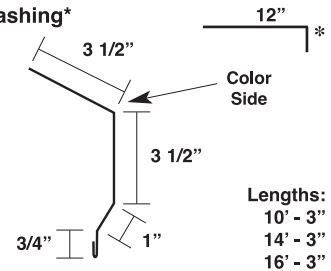

Color Side
Lengths:
10' - 3"
14' - 3"
16' - 3"

**Gutter Apron*
(P-GA)**

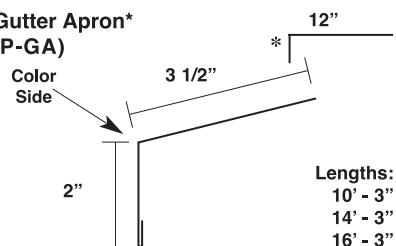

Color Side
Lengths:
10' - 3"
14' - 3"
16' - 3"

**Rake and Gable Trim
(P-RF)**

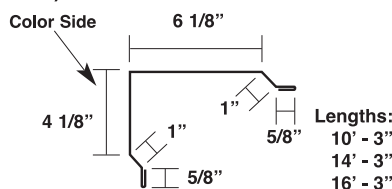

Color Side
Lengths:
10' - 3"
14' - 3"
16' - 3"

**Shingle Rake Trim
(P-SRT)**

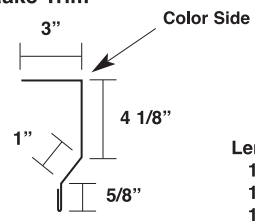

Color Side
Lengths:
10' - 3"
14' - 3"
16' - 3"

**Rake Tie-In Trim
(P-EWF)**

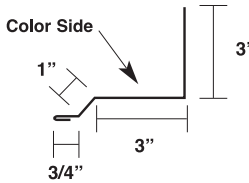

Color Side
Lengths:
10' - 3"
14' - 3"
16' - 3"

**High Side Trim*
P-HSE**

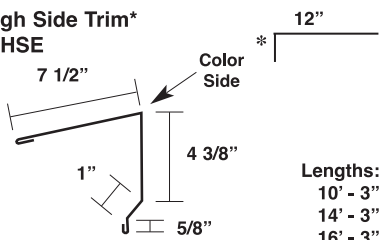

Color Side
Lengths:
10' - 3"
14' - 3"
16' - 3"

**High Side Tie-In*
(P-SWF)**

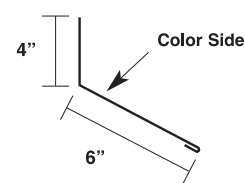

Color Side
Lengths:
10' - 3"
14' - 3"
16' - 3"

*specify roof pitch

MAX-RIB / MESA

TRIM POST FRAME

29 GA

Gambrel Lower*
(P-GL)

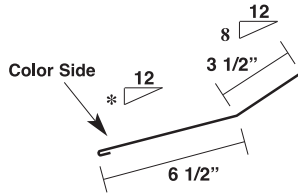

Lengths:
10' - 3"
14' - 3"
16' - 3"

Gambrel Upper*
(P-GU)

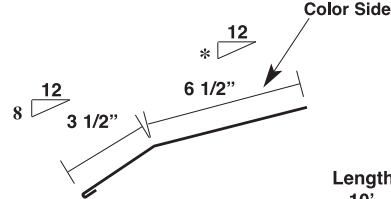

Lengths:
10' - 3"
14' - 3"
16' - 3"

Ridge Cap*
(P-RC-13)

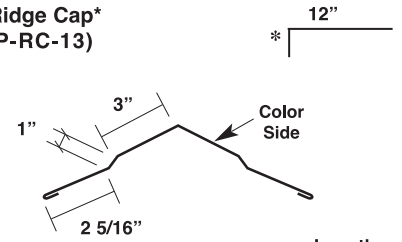

Lengths:
10' - 3"
14' - 3"
16' - 3"

Ridge Cap*
(P-RC-20)

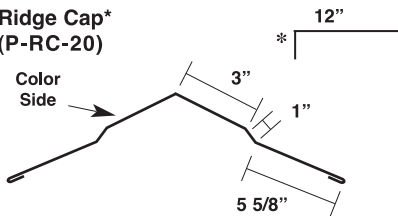

Lengths:
10' - 3"
14' - 3"
16' - 3"

Ridge Cap*
(P-RC-23)

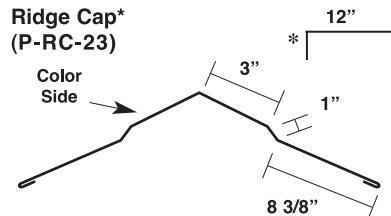

Lengths:
10' - 3"
14' - 3"
16' - 3"

6" K Gutter
6KGT

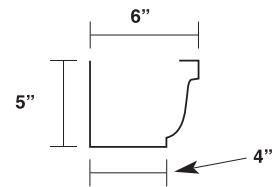

Lengths:
16' - 3" Marshall Facility Only
20' - 6" Lewisport Facility Only

6" K Outside Miter Box
6KOMB

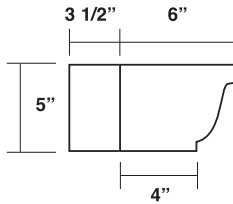

Lengths:
9 1/2"
(Visible)

Not Inventoried at all Locations

6" K Inside Miter Box
6KIMB

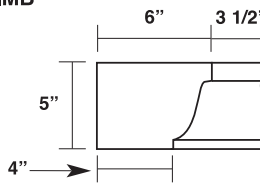

Lengths:
3.5"
(Visible)

6" End Cap
6KREC (Right)
6KLEC (Left)

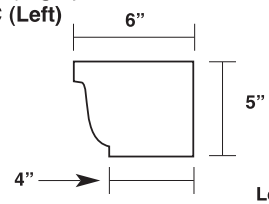

Lengths:
6"

Not Inventoried at all Locations

Downspout 3" x 4"
29 Ga. = 6KDS14
26 Ga. = BBPDS

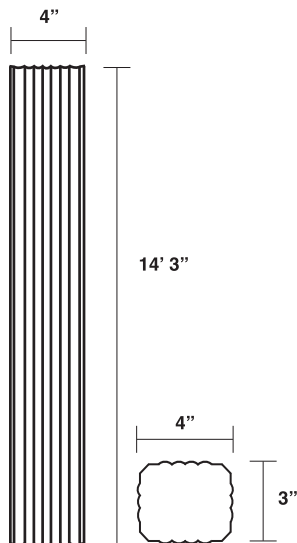

Lengths:
14' - 3"

29 Ga. only available at the Marshall and Lewisport locations.

6" Aluminium Hanger w/Fastener
HANGER

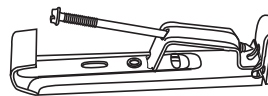

Lengths:
6"

Not Inventoried at all Locations

Aluminium Downspout Outlet
BBPOUT

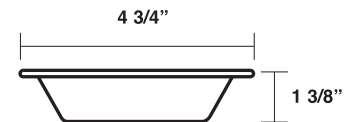

Downspout Strap
BBPDSS

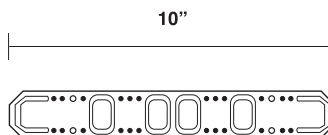

Lengths:
10"

Only available in 26 Ga.

3" x 4" Downspout Elbow A-Style
29 Ga. = 6KELA
26 Ga. = BBPELA

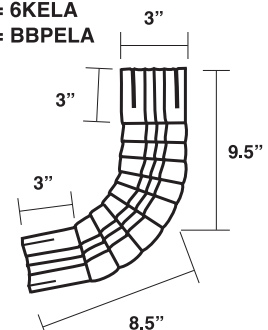

29 Ga. only available at the Marshall and Lewisport locations.

MAX-RIB / MESA

TRIM RESIDENTIAL

26 GA

Panel Cap
(R-PC)

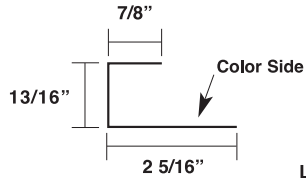

Lengths:
10' - 3"
20' - 3"

Eave Trim*
(R-EF)

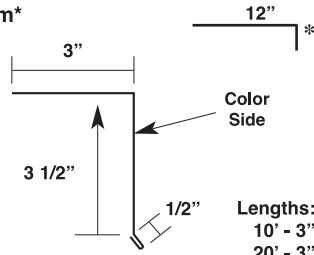

Lengths:
10' - 3"
20' - 3"

D-Edge / Rake Trim
(For Use at Rakes Only)
(R-DE)

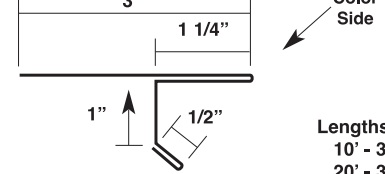

Lengths:
10' - 3"
20' - 3"

Rake Trim
(R-RT)

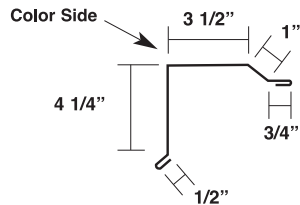

Lengths:
10' - 3"
20' - 3"

Rake Tie-In
(R-EW)

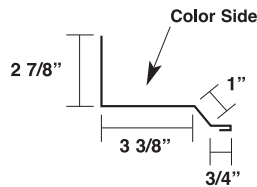

Lengths:
10' - 3"
20' - 3"

Hi-Side Trim*
(R-HS)

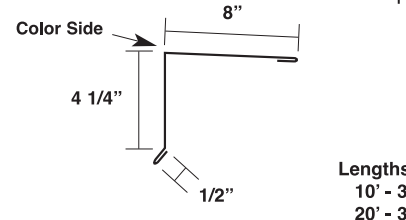

Lengths:
10' - 3"
20' - 3"

Hi-Side Tie-In*
(R-SW)

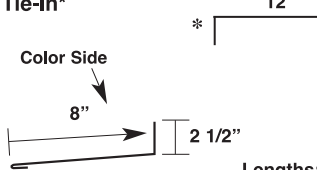

Lengths:
10' - 3"
20' - 3"

Ridge Trim*
(R-RF)

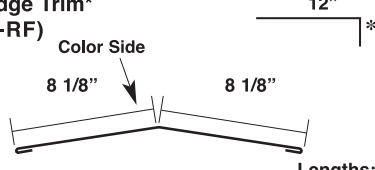

Lengths:
10' - 3"
20' - 3"

Ridge Cap*
(R-RC-13)

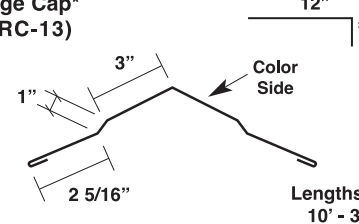

Lengths:
10' - 3"

Hip Trim*
(R-HF)

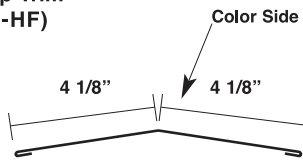

Lengths:
10' - 3"
20' - 3"

Valley Trim*
(R-VF)

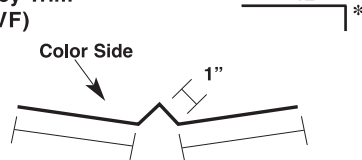

Lengths:
10' - 3"

Gutter Trim*
(R-GT)

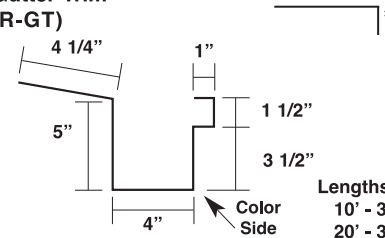

Lengths:
10' - 3"
20' - 3"

Gutter Strap
(RES-GS)

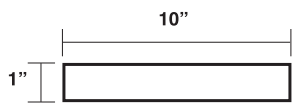

Lengths:
10"

Gutter End Cap
Right Hand (R-GEC) or
Left Hand (L-GEC)

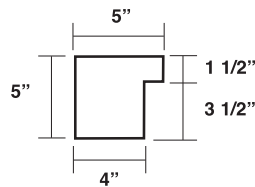

Notes:

*specify roof pitch

MAX-RIB / MESA

ACCESSORIES

#10 - 15 Type A
Woodgrip MAC
(Part # varies by color)

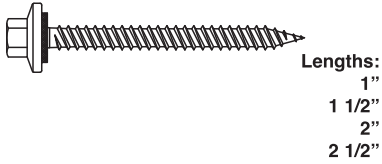

#10 - 15
Woodgrip HILO ZAC
(Part # varies by color)

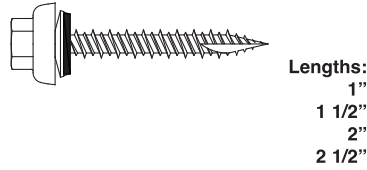

#9 - 15 Type A Woodgrip
W/Washer
(Part # varies by color)

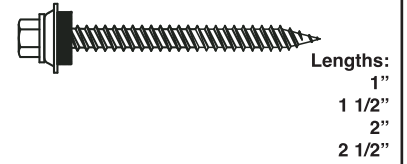

#12-8 Woodgrip XG
(Part # varies by color)

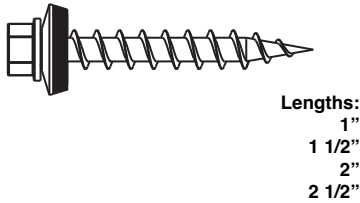

1/4 - 14 x 7/8"
LAPTEK W/Washer
(Part # varies by color)

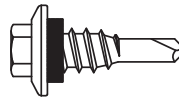

1/4 - 14 x 7/8"
LAPTEK ZAC
Self-Driller
(Part # varies by color)

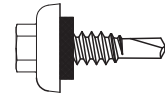

Bi-Metal
Evergrip - ACQ x 1 1/2"
(Part # varies by color)

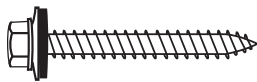

43D PopRivets
(Part # varies by color)

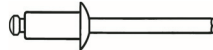

Touch-Up Paint - Pen
(Part # varies by color)



Roll Tape Sealant
3/32" x 3/8" x 45'
Item #: 95340

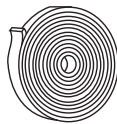

Roll Tape Sealant
3/32" x 1" x 45'
Item #: 95335

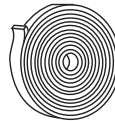

Titebond Caulk Sealant
(Part # varies by color)



Sikalastomer Butyl Sealant
Item #: 95342



Max-Rib
Inside Closure
W/Out Adhesive - Item #: 95170
With Adhesive-Item #: 95182

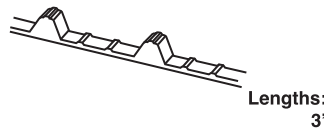

Max-Rib
Outside Closure
W/Out Adhesive-Item #: 95180
With Adhesive-Item #: 95184

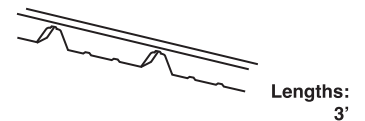

Mesa
Inside Closure
With Adhesive-Item #: 95186

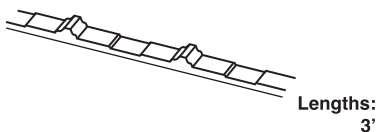

Mesa
Outside Closure
With Adhesive-Item #: 95188

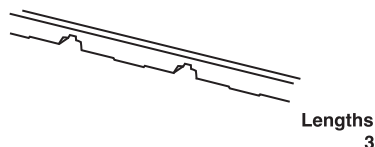

Max-Rib
5 oz. Fiberglass Panel
Available in Clear and White



MAX-RIB / MESA

ACCESSORIES

Sunsy Clear
Polycarbonate Panel (For MAX-RIB)
Soft White



Lengths:
8'
10'
12'

Not Inventoried at all Locations

Sunsy Clear
Polycarbonate Panel (For MAX-RIB)
White Opal



Lengths:
8'
10'
12'

Not Inventoried at all Locations

Sunsy
Polycarbonate Panel (For MESA)
Soft White



Lengths:
8'
10'

Not Inventoried at all Locations

Sunsy
Polycarbonate Panel (For MESA)
White Opal



Lengths:
8'
10'
12'

Not Inventoried at all Locations

23" Fiberglass Ridge Lite

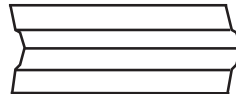

Lengths:
10' - 6"

Not Inventoried at all Locations

Versa Vent
3" X 1"
Item #: 98105

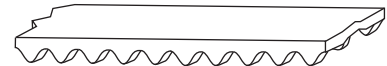

Lengths:
10 pcs @ 10' = 100LF
Per Box

Not Inventoried at all Locations

Profile Vent
Item #: 97745

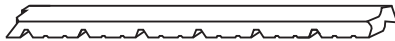

Lengths:
Two 50'
Rolls Per Box

Not Inventoried at all Locations

Swenson Shear
Item #: 94430 - Max-Rib
Item #: 94501 - Mesa

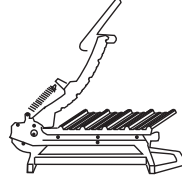

Not Inventoried at all Locations

Dektite Flashing Roof
or Wall Pipe

1/2" - 2" Item #: 97242
1/4" - 4" Item #: 97244
4" - 7" Item #: 97246
6" - 11" Item #: 97248
7" - 13" Item #: 97249

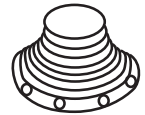









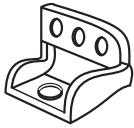

Other Sizes Available Upon Request

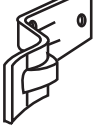
Notes:

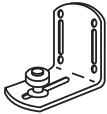
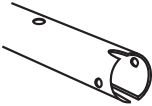
MAX-RIB / MESA

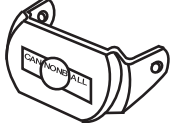
CANNONBALL ACCESSORIES

Cannonball Accessories are not inventoried at all locations.

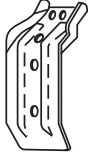
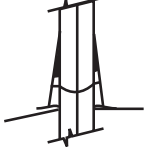
<p>Face Mount Cover Bracket Item #: 99710</p> 	<p>Cam Latch (1 Pair Left and Right) Item #:99745</p> 	<p>White Door Pull Item #: 99750</p> 
<p>Galvanized Heavy Duty Door Stop Item #: 99765</p> 	<p>White Adjustable Guide or Stop Item #:99770</p> 	<p>Offset Adjustable Stay Roller Item #: 99775</p> 
<p>Galvanized Key Track 8' Item #: 99700 10' Item #: 99705</p> 	<p>Galvanized Splice Collar Item #: 99720</p> 	<p>Galvanized End Cap with Bolt Item #: 99730</p> 
<p>Face Mount Bracket Track / Cover Item #: 99715</p> 	<p>9" Adjustable Trolley Hanger Item #: 99725</p> 	<p>Face Mount End Cap Trim Item #: 99735</p> 
<p>Top Mount Bracket Track/Cover Item #: 99716</p> 	<p>Wood Frame Door Snugger 21 Link Item #: 99740</p> 	

CANNONBALL ACCESSORIES - QUICK FRAME

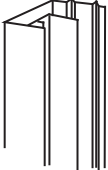
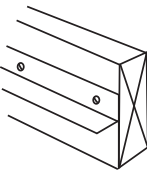
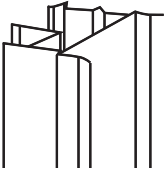
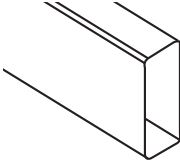
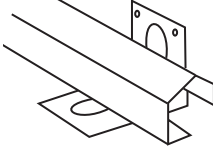
<p>Side Rail #200</p>  <p>Lengths: 10' 12' 14' 16'</p>	<p>Bottom Rail #201</p>  <p>Lengths: 10' 12' 16'</p>	<p>Double Coupler #216B</p>  <p>Lengths: 10' 12' 16'</p>
<p>Horizontals #235</p>  <p>Lengths: 10' 12' 16'</p>	<p>Stay Guide II</p>  <p>Lengths: 8' 10'</p>	



☆ MANUFACTURING LOCATIONS ● SERVICE CENTERS ★ MANUFACTURING AND SERVICE CENTER



CORPORATE OFFICE
 1500 HAMILTON RD.
 BOSSIER CITY, LA 71111

MANUFACTURING LOCATIONS

- | | | | | |
|--------------|--------------------|------------------|----------------|-------------|
| ADELANTO, CA | ASHBURN, GA | BOSSIER CITY, LA | CLINTON, IL | DIAMOND, MO |
| HOUSTON, TX | LEWISPORT, KY | LOCKHART, TX | MARSHALL, MI | MAUSTON, WI |
| MERKEL, TX | PEACHTREE CITY, GA | SUNNYVALE, TX | WINCHESTER, VA | |

MCELROY METAL
SERVICE
 CENTER
 EMPLOYEE OWNED

17031 Koala Road Adelanto, CA 92301	5215 Leo St. Alexandria, LA 71301	1007 Wilso Dr, Baltimore, MD 21223	1500 Hamilton Rd. Bossier City, LA 71111
3052 Yadkin Road Chesapeake, VA 23323	9476 Meadowbrook Rd. Clinton, IL 61727	3215 Highway 59 Diamond, MO 64840	390 N. Valley Dell Dr. Fenton, MO 63026
409 Lovejoy Road Ft. Walton Beach, FL 32548	3014 Lincoln Court Garland, TX 75041	1440 Aldine Bender Road Houston, TX 77032	10504 E. 59th Street Indianapolis, IN 46236
32 Industrial Circle Lancaster, PA 17601	9435 US Hwy. 60 W. Lewisport, KY 42351	2701 Cahill Street Lockhart, TX 78644	1020 Veterans Street Mauston, WI 53948
5123 Terminal Dr. McFarland, WI 53558	514 Cave Road Nashville, TN 37210	8304 Hwy. 70 E. North Little Rock, AR 72117	613 North Bierdeman Rd. Pearl, MS 39208
8511 Industrial Drive Pearland, TX 77584	2755 Hwy 60 Pendergrass, GA 30567	7450 Tower Street Richland Hills, TX 76118	8200 Berry Ave. Suite 100 Sacramento, CA 95828
1365 Dean Forest Rd. Savannah, GA 31405	7355 Oakley Industrial Blvd. Union City, GA 30291	1144 Silstar Rd. West Columbia, SC 29170	325 McGhee Rd. Winchester, VA 22603

Website: www.mcelroymetal.com • E-mail: info@mcelroymetal.com