

MERIDIAN

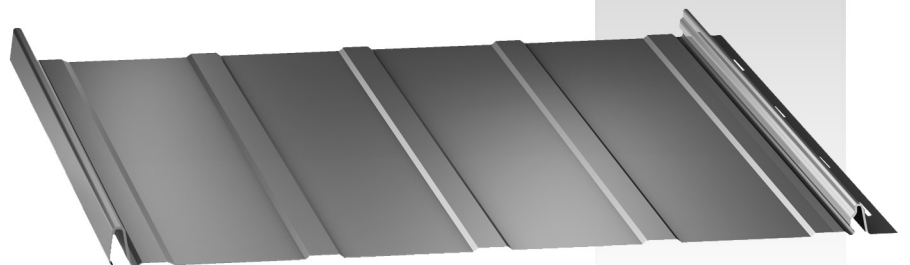

Panel/Trim/Accessories



MERIDIAN

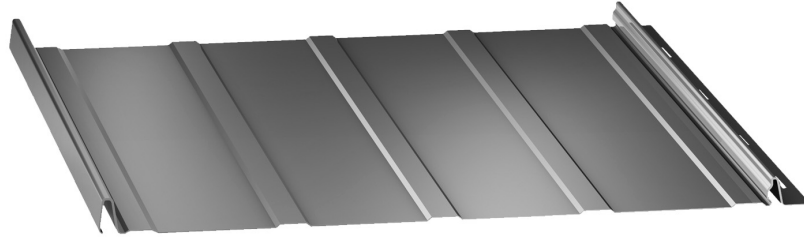

Meridian

Pan Conditions for 12"

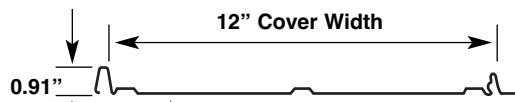

12" MERIDIAN PANEL MINOR RIB 24 GAUGE ONLY

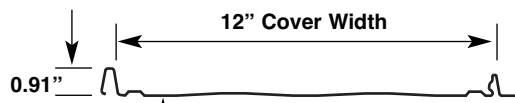

12" MERIDIAN PANEL STRIATED 24 GAUGE ONLY

Pan Conditions for 16"

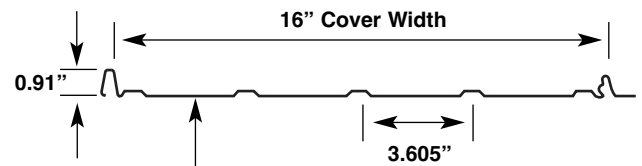

16" MERIDIAN PANEL MINOR RIBS

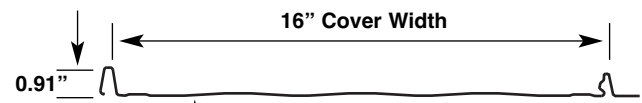

16" MERIDIAN PANEL STRIATED

Meridian Tables and Section Properties

For any available Testing Data, Section Properties, or Load Tables, please visit www.mcelroymetal.com. For additional information, please contact the **McElroy Engineering Department at 1-800-950-9082**.

Details:

- Factory formed eave notch upon request
- Minimum slope: 3:12
- Must be installed over solid deck
- Oil canning is a natural occurrence in metal panels and is not cause for panel rejection
- Contents in this manual are subject to change without notice. To confirm this book is the most current copy, please visit McElroy's website at www.mcelroymetal.com

Note:

- Meridian manufactured in Sunnyvale, TX features a slightly different lap and should not be mixed with panels from other facilities

Panel Options:

- Panel width: 12" and 16"
- Panel configurations:
 - 16" minor ribs or striated
 - 12" minor ribs or striated
- Coating:
 - Kynar 500® (PVDF)
- Substrate:
 - Standard 26 GA Galvalume® 16" only
 - Standard 24 GA Galvalume 12" and 16"

MERIDIAN

TRIM FOR EXPOSED FASTENED APPLICATIONS

26 GA

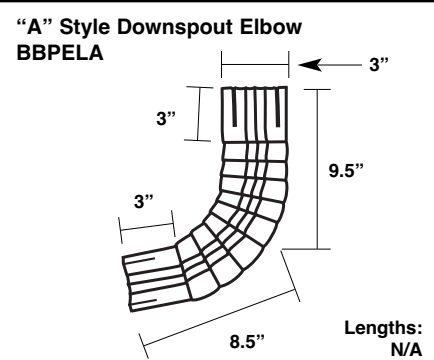
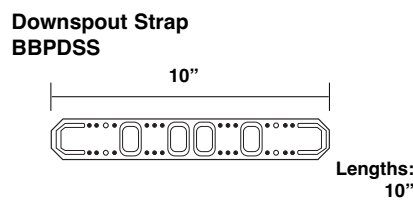
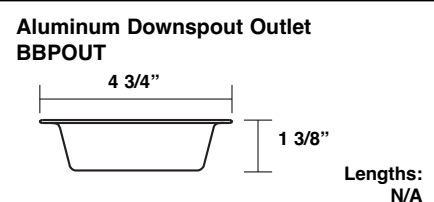
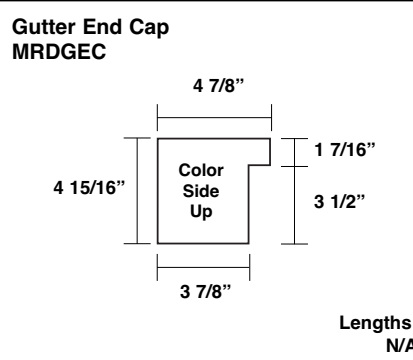
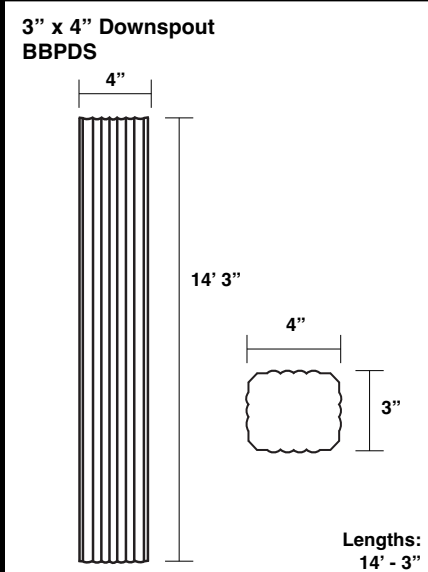
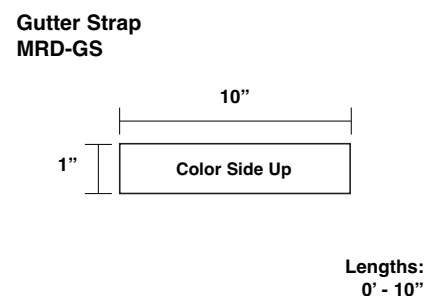
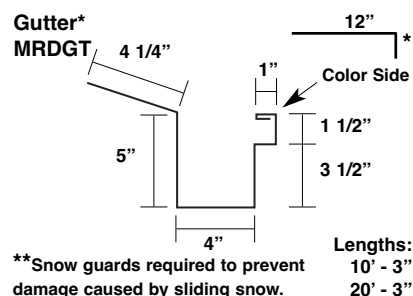
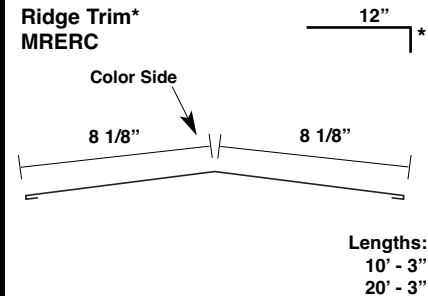
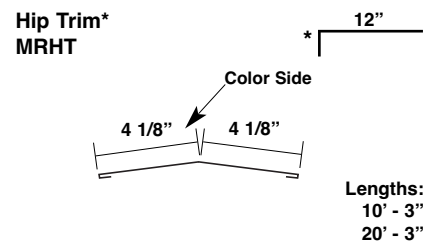
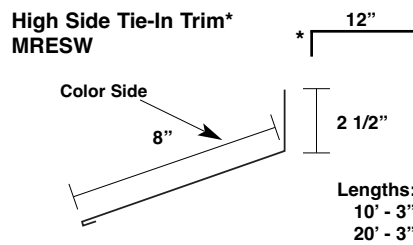
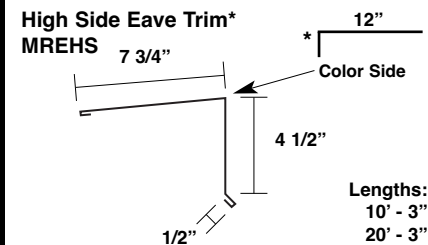
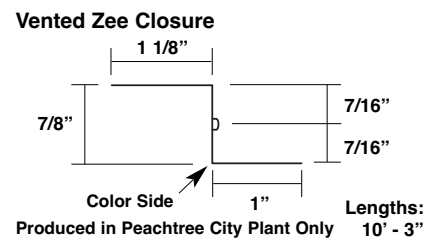
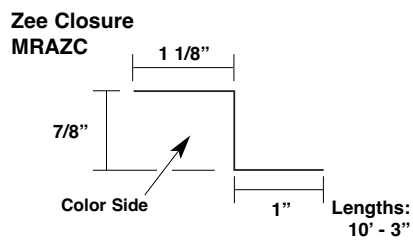
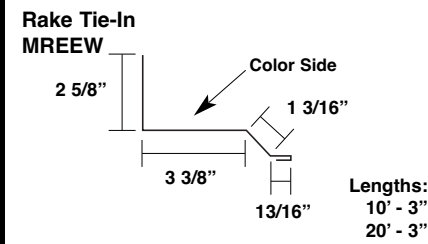
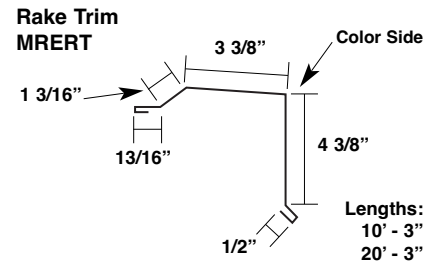
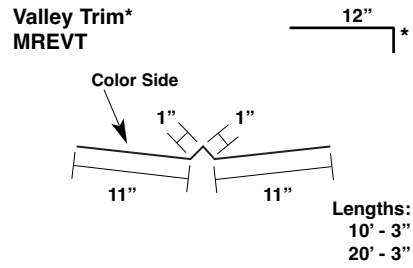
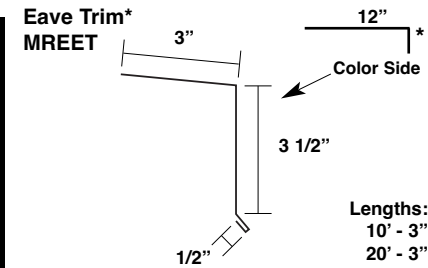

MERIDIAN

TRIM FOR ARCHITECTURAL APPLICATIONS

26 GA

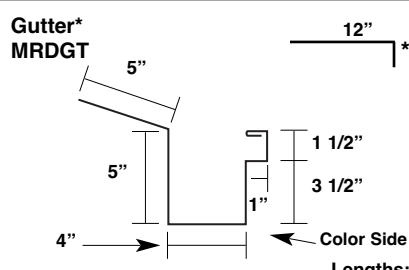
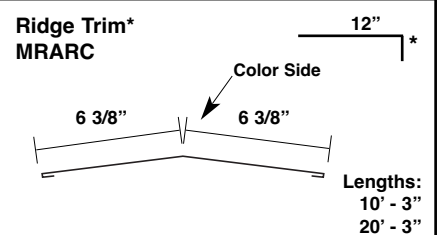
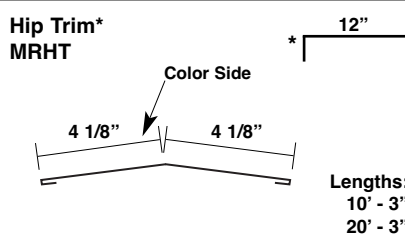
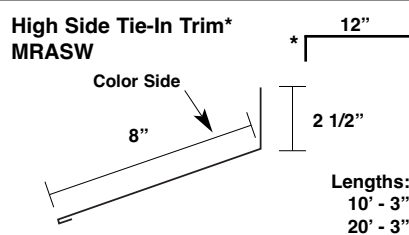
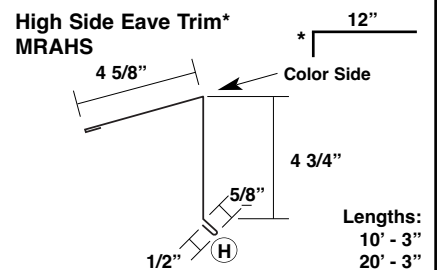
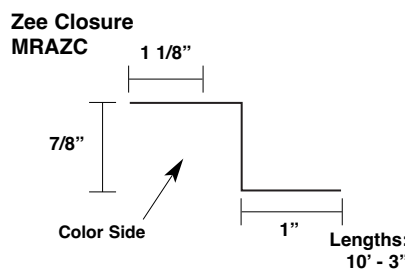
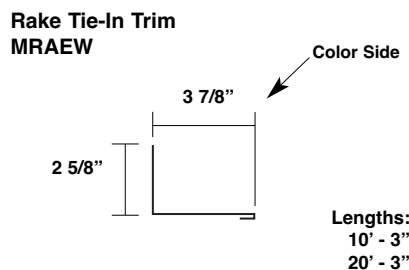
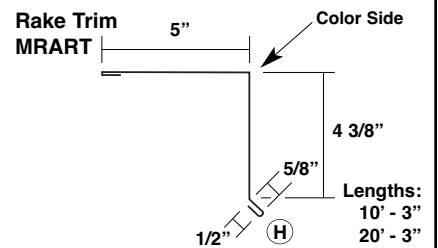
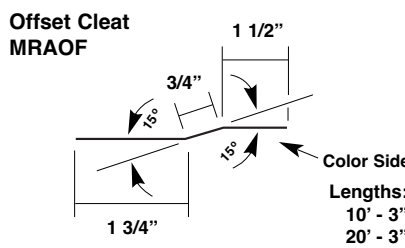
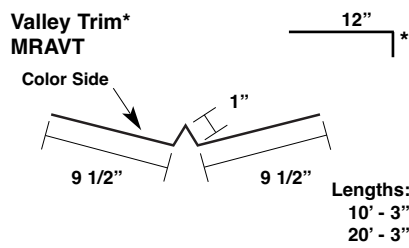
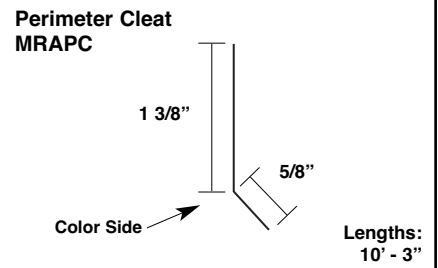
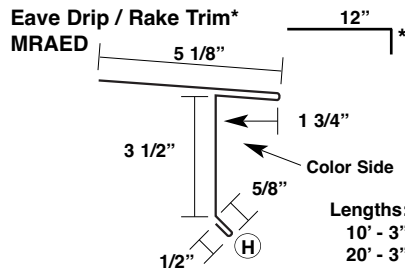
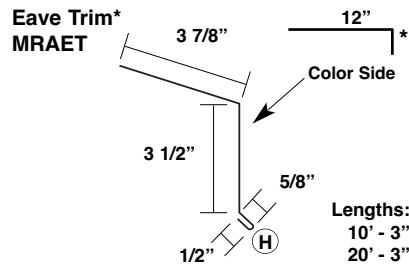

**Snow guards required to prevent damage caused by sliding snow.

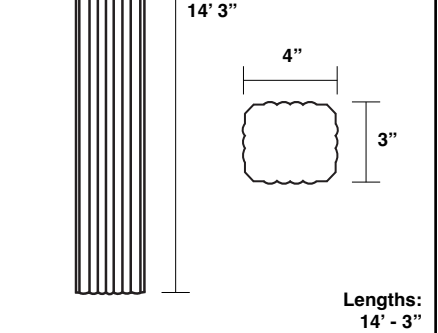
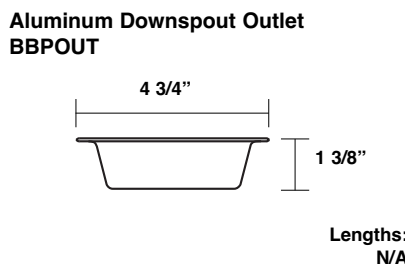
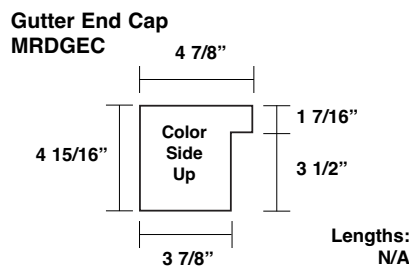
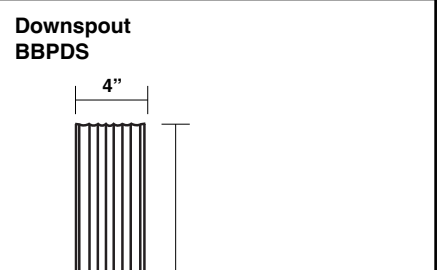
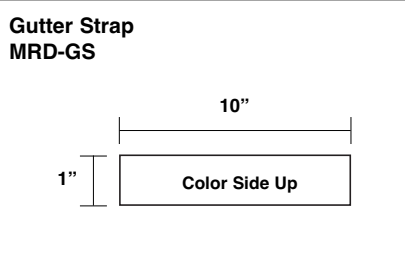

MERIDIAN

TRIM FOR ARCHITECTURAL APPLICATIONS

26 GA

Downspout Strap
BBPDSS

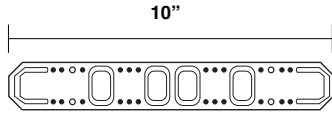

Lengths:
10"

3" x 4"
Downspout Elbow
A-Style
BBPELA

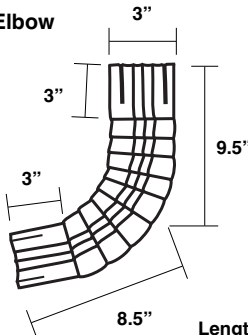

Lengths:
N/A

ACCESSORIES

1/4 - 14 x 7/8" LAPTEK ZAC
Self Driller
(Part # varies by color)

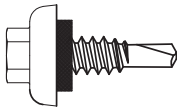

#9 - 15 x 1" Type A Woodgrip
W/O Washer - Plain
Item #: 36115



#10 - 15 Woodgrip
HILO ZAC
(Part # varies by color)

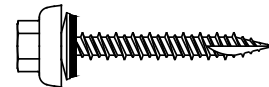

#10 - 12 x 1" Type A Pancake Head
Woodgrip
Item #: 36116

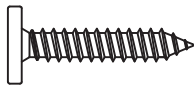

Titebond Caulk Sealant
(Part # varies by color)



White Urethane Sealant
Item #: 95320



Sikalastomer 511 Butyl Tube Sealant
Item #: 95342



Roll Tape Sealant 3/32" x 1" x 45'
Item #: 95335

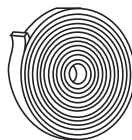

Dektite Flashing Roof or Wall Pipe

1/2" - 2" Item #: 97242
1/4" - 4" Item #: 97244
4" - 7" Item #: 97246
6" - 11" Item #: 97248
7" - 13" Item #: 97249

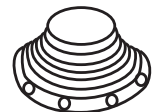

Inside Closure Plug
Item #: 95072



Outside Closure
12" w-Adhesive Item #: 95067
16" w-Adhesive Item #: 95066
** Each Closure Covers 2 Panels



43D Pop Rivet
(Part # varies by color)



Touch-Up Paint Pen
(Part # varies by color)



Hemming Tool
Item #: 36120

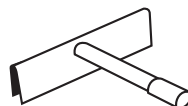

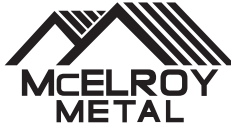

☆ MANUFACTURING LOCATIONS ● SERVICE CENTERS ★ MANUFACTURING AND SERVICE CENTER



CORPORATE OFFICE
 1500 HAMILTON RD.
 BOSSIER CITY, LA 71111

MANUFACTURING LOCATIONS

ADELANTO, CA	ASHBURN, GA	BOSSIER CITY, LA	CLINTON, IL	DIAMOND, MO
HOUSTON, TX	LEWISPORT, KY	MARSHALL, MI	MAUSTON, WI	MERKEL, TX
	PEACHTREE CITY, GA	SUNNYVALE, TX	WINCHESTER, VA	

MCELROY METAL
SERVICE
 CENTER

5215 Leo St. Alexandria, LA 71301	1007 Wilso Dr, Baltimore, MD 21223	1500 Hamilton Rd. Bossier City, LA 71111	3052 Yadkin Road Chesapeake, VA 23323
9476 Meadowbrook Rd. Clinton, IL 61727	3215 Highway 59 Diamond, MO 64840	390 N. Valley Dell Dr. Fenton, MO 63026	409 Lovejoy Road Ft. Walton Beach, FL 32548
3014 Lincoln Court Garland, TX 75041	1440 Aldine Bender Road Houston, TX 77032	10504 E. 59th Street Indianapolis, IN 46236	9435 US Hwy. 60 W. Lewisport, KY 42351
1020 Veterans Street Mauston, WI 53948	5123 Terminal Dr. McFarland, WI 53558	514 Cave Road Nashville, TN 37210	8304 Hwy. 70 E. North Little Rock, AR 72117
613 North Bierdeman Rd. Pearl, MS 39208	7450 Tower Street Richland Hills, TX 76118	5300 83rd Street Sacramento, CA 95826	1365 Dean Forest Rd. Savannah, GA 31405
7355 Oakley Industrial Blvd. Union City, GA 30291	1144 Silstar Rd. West Columbia, SC 29170	325 McGhee Rd. Winchester, VA 22603	

Website: www.mcelroymetal.com · E-mail: info@mcelroymetal.com