

# MEDALLION-LOK

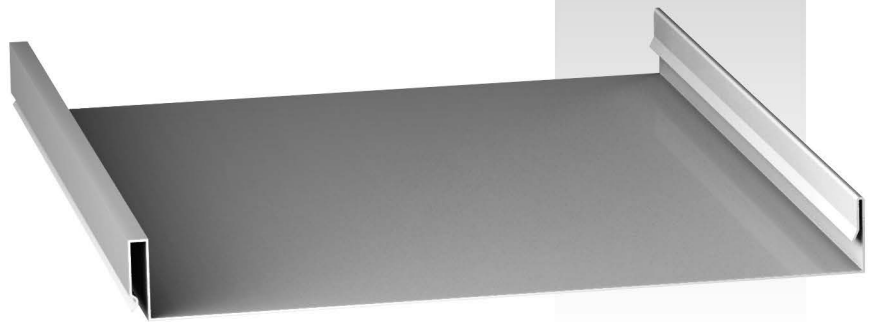

**Panel / Trim / Accessories**







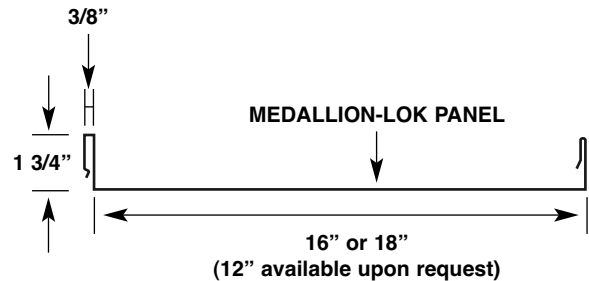
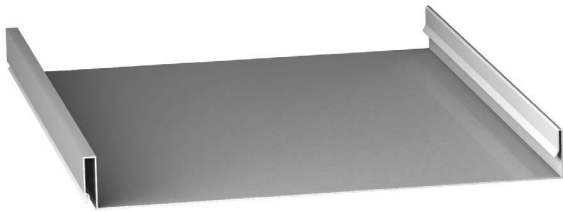

# MEDALLION-LOK

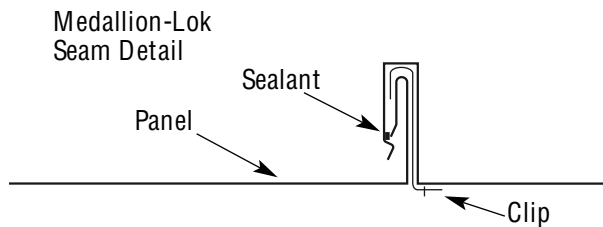

## Medallion-Lok

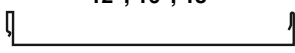
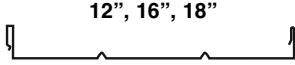

## Pan Conditions

MEDALLION-LOK STRIATED*	
MEDALLION-LOK FLAT PAN	
MEDALLION-LOK DOUBLE PENCIL RIBS	
MEDALLION-LOK SINGLE PENCIL RIB	
*Recommended Pan Condition	12" Only

## Medallion-Lok Load Tables and Section Properties

Load tables and section properties for Medallion-Lok can be found online at [www.mcelroymetal.com](http://www.mcelroymetal.com). Please contact the **McElroy Engineering Department** at 1-800-950-9082 for additional information.

### Notes:

- Standard Medallion-Lok panel features a Galvalume Substrate with Kynar 500® (PVDF) coating. Standard gauge for panel and trim is 24 gauge. Other gauges and aluminium are available upon request.
- Minimum length is 3' 9" or 4' 0", depending on production facility. Maximum standard length is 50'. Longer lengths available upon request.
- Additional fees may apply for panel lengths under 4' and over 50'.
- Medallion-Lok can be factory notched on the eave end of the panel. This is available for a left to right or a right to left roof condition.
- Oil canning is inherent in all metal panels and is not cause for panel rejection. A signed pan waiver will be required for all Medallion-Lok orders prior to production.
- Available pan conditions include: Double Pencil Ribs, Striations or Flat Pan. Striated panels are recommended as they reduce the appearance of oil canning.
- Contact a McElroy Representative for specific pricing, lead times and special colors or gauges that may not be on a McElroy Metal color chart.
- Contents in this manual are subject to change without notice. To confirm this book is the most current copy, please visit McElroy's website at [www.mcelroymetal.com](http://www.mcelroymetal.com).

# MEDALLION-LOK

## TRIM

24 GA

**Soffit Base Trim  
MDSB**

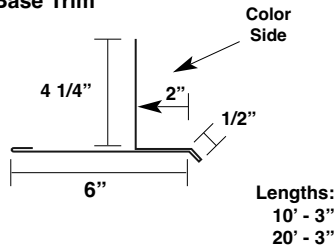

**Outside Corner  
MDOC**

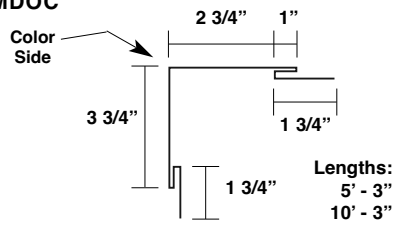

**Inside Corner  
MDIC**

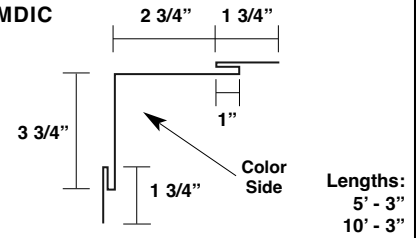

**Eave Trim\*  
MDET**

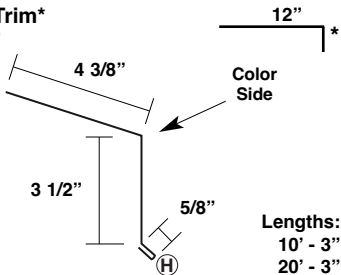

**Eave Drip / Rake  
1 1/2" Leg\*  
MDDE**

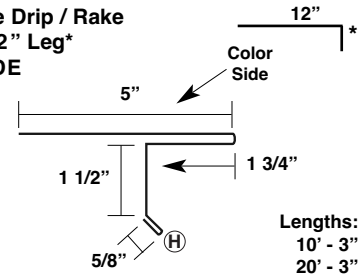

**Eave Drip / Rake  
3 1/2" Leg\*  
MDED**

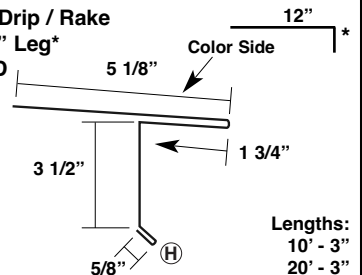

**Perimeter Cleat  
MDPC**

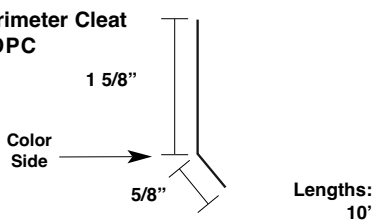

**Perimeter Zee Trim  
MDLPZ**

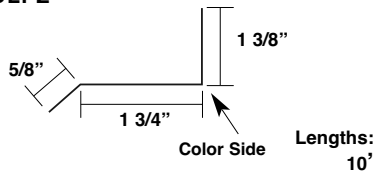

**Valley Trim\*  
MDVT**

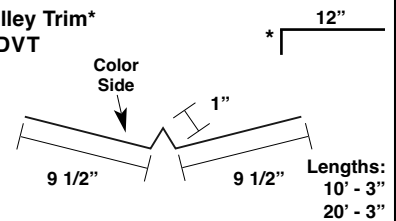

**Offset Cleat  
MDOF**

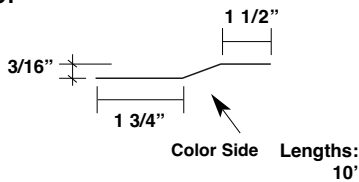

**Rake Trim  
MDLRT**

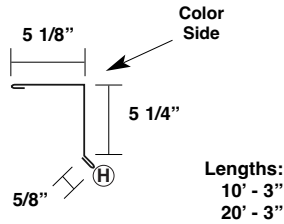

**Rake Tie-In Trim  
MDEW**

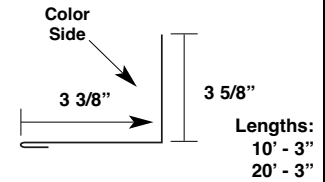

**Zee Closure  
MDLZC**

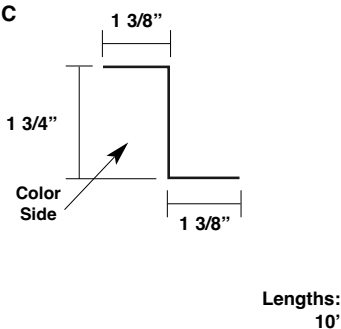

**Vented Zee Closure**

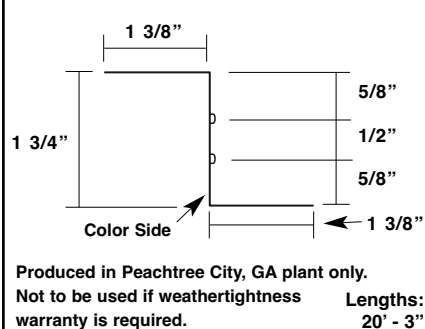

**Hi-Side Trim\*  
MDLHS**

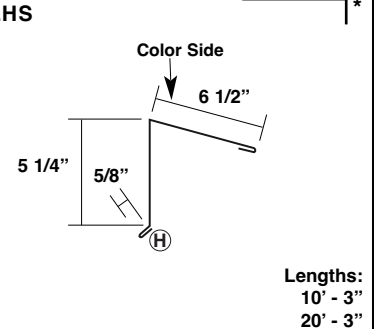

**Hi-Side Tie-In Trim\*  
MDSW**

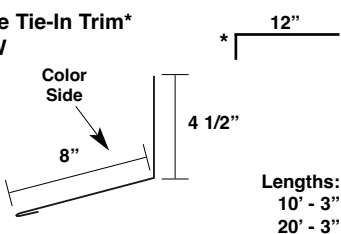

**Hip Flashing\*  
MDHF**

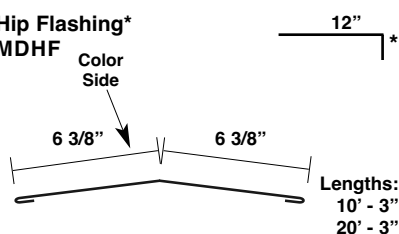

**Ridge Flashing\*  
MDRF**

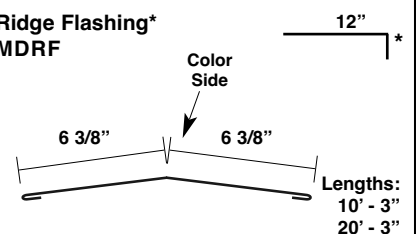

# MEDALLION-LOK

## TRIM

<p><b>**Gutter Trim*</b> MDEG</p> <p><b>**Snow guards required to prevent damage caused by sliding snow.</b></p> <p>Lengths: 10' - 3" 20' - 3"</p>	<p><b>Gutter Strap</b> MDGS</p> <p>Color Side Up</p> <p>Lengths: 10"</p>	<p><b>Gutter End Cap</b> MDGECL (Left) MDGECR (Right)</p> <p>Color Side Up</p> <p>Lengths: N/A</p> <p>26 Ga.</p>
<p><b>Aluminum Downspout Outlet Box</b> BBPOUT</p> <p>Lengths: N/A</p>	<p><b>Downspout</b> BBPDS</p> <p>Lengths: 14'-3"</p>	<p><b>Downspout Strap</b> BBPDSS</p> <p>Lengths: 10"</p> <p>Only available in 26 Ga.</p>
<p><b>3" x 4" Downspout Elbow</b> A-Style BBPELA</p> <p>Lengths: N/A</p> <p>Only available in 26 Ga.</p>	<p><b>Downspout</b> BBPDS</p> <p>Lengths: 14'-3"</p> <p>Only available in 26 Ga.</p>	

## ACCESSORIES

<p><b>Medallion-Lok Standard Clip</b> Item #: 36512</p>	<p><b>Medallion-Lok UL-90 Clip</b> Item #: 36515</p>	<p><b>Utility Eave Plate</b> Item #: 11197 Primed: 17477 Galvanized: Item 221025</p> <p>Lengths: 10'</p>
<p><b>Bearing Plate</b> Primed Item #: 94599 Galvanized Item #: 203541</p> <p>2 11/32"    2 11/32"</p>	<p><b>#9 - 15 x 1" Type A Woodgrip</b> W/O Washer - Plain Item #: 36115</p>	<p><b>1/4 - 14 x 1 1/4" TEK2 Self Driller</b> W/O Washer - Plain Item #: 10969</p>

# MEDALLION-LOK

## ACCESSORIES

#10 - 12 x 1" Type A  
Pancake Head  
Woodgrip  
Item #: 36116001

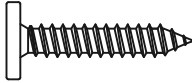

#10 - 16 x 1" TEK2  
Pancake Head  
Self-Driller  
Item #: 36117

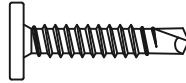

1/4 - 14 x 7/8" LAPTEK ZAC  
Self Driller  
(Part # Varies by Color)

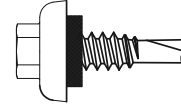

#12 - 13 DEKFAST Philips  
(Length Varies by Application)



#14 - 13 DEKFAST Philips  
(Length Varies by Application)



43D PopRivets  
(Part # Varies by Color)

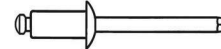

Roll Tape Sealant  
3/32" x 1" x 45'  
Item #: 95335

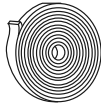

Titebond Caulk Sealant  
(Part # varies by color.)



White Urethane Sealant  
Item #: 95320



Butyl Tube Sealant  
Item #: 95342



Touch-Up Paint Pen  
(Part # Varies by Color)



Hemming Tool  
Item #: 36120

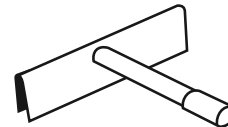

Notes:

Blank area for notes.





☆ MANUFACTURING LOCATIONS ● SERVICE CENTERS ★ MANUFACTURING AND SERVICE CENTER



**CORPORATE OFFICE**  
1500 HAMILTON RD.  
BOSSIER CITY, LA 71111

**MANUFACTURING LOCATIONS**

ADELANTO, CA	ASHBURN, GA	BOSSIER CITY, LA	CLINTON, IL	DIAMOND, MO
HOUSTON, TX	LEWISPORT, KY	LOCKHART, TX	MARSHALL, MI	MAUSTON, WI
MERKEL, TX	PEACHTREE CITY, GA	SUNNYVALE, TX	WINCHESTER, VA	

**McELROY METAL**  
**SERVICE**  
**CENTER**  
EMPLOYEE OWNED

17031 Koala Road Adelanto, CA 92301	5215 Leo St. Alexandria, LA 71301	1007 Wilso Dr, Baltimore, MD 21223	1500 Hamilton Rd. Bossier City, LA 71111
3052 Yadkin Road Chesapeake, VA 23323	9476 Meadowbrook Rd. Clinton, IL 61727	3215 Highway 59 Diamond, MO 64840	390 N. Valley Dell Dr. Fenton, MO 63026
409 Lovejoy Road Ft. Walton Beach, FL 32548	3014 Lincoln Court Garland, TX 75041	1440 Aldine Bender Road Houston, TX 77032	10504 E. 59th Street Indianapolis, IN 46236
32 Industrial Circle Lancaster, PA 17601	9435 US Hwy. 60 W. Lewisport, KY 42351	2701 Cahill Street Lockhart, TX 78644	1020 Veterans Street Mauston, WI 53948
5123 Terminal Dr. McFarland, WI 53558	514 Cave Road Nashville, TN 37210	8304 Hwy. 70 E. North Little Rock, AR 72117	613 North Bierdeman Rd. Pearl, MS 39208
8511 Industrial Drive Pearland, TX 77584	2755 Hwy 60 Pendergrass, GA 30567	7450 Tower Street Richland Hills, TX 76118	8200 Berry Ave. Suite 100 Sacramento, CA 95828
1365 Dean Forest Rd. Savannah, GA 31405	7355 Oakley Industrial Blvd. Union City, GA 30291	1144 Silstar Rd. West Columbia, SC 29170	325 McGhee Rd. Winchester, VA 22603

Website: [www.mcelroymetal.com](http://www.mcelroymetal.com) • E-mail: [info@mcelroymetal.com](mailto:info@mcelroymetal.com)