

MAXIMA

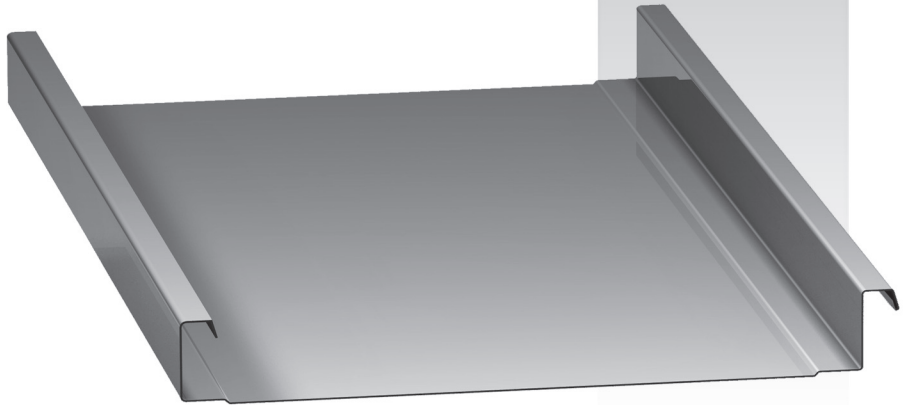

Panel / Trim / Accessories



MAXIMA

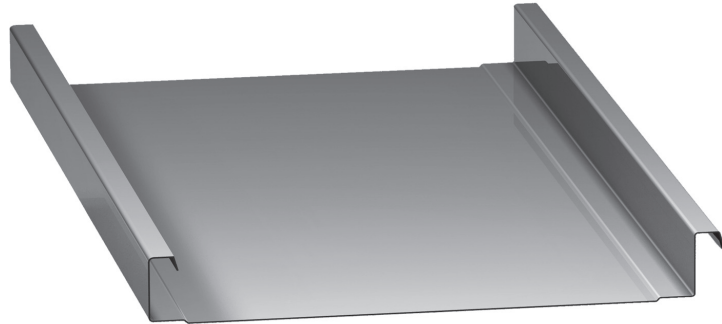







Maxima

Maxima Testing Data, Section Properties, and Load Tables

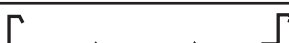
For any available Testing Data, Section Properties, or Load Tables, please visit www.mcelroymetal.com. For additional information, please contact the **McElroy Engineering Department at 1-800-950-9082**.

Maxima Panel Availability

MAXIMA PROFILES	WIDTH	PAN CONDITIONS			FACTORY NOTCHING			SEAM			
	WIDTH IN INCHES	STRIATED	DOUBLE PENCIL RIB	SINGLE PENCIL RIB	FLAT PAN	CURVED	LAP	EAVE	NONE	90 DEGREE SEAM	180 DEGREE SEAM
 MAXIMA 1.5" SHOWN AS STRIATED	12	■	■	■	■	■	■	■	■	■	■
 MAXIMA 1.5" SHOWN AS STRIATED	16, 18	■	■	■	■	■	■	■	■	■	■
 MAXIMA 2" SHOWN AS FLAT PAN (OPT.) <small>(SINGLE PENCIL RIB AVAILABLE IN 12" ONLY)</small>	12	■	■	■	■	■	■	■	■	■	■
 MAXIMA 2" SHOWN AS BEAD (PENCIL) RIB (OPT.)	16, 18	■	■	■	■	■	■	■	■	■	■
 MAXIMA ADV 2" SHOWN AS STRIATED	12	■	■	■	■	■	■	■	■	■	■
 MAXIMA ADV 2" SHOWN AS STRIATED	16, 18	■	■	■	■	■	■	■	■	■	■
 MAXIMA 3" SHOWN AS MINOR RIB (STD.) <small>(18" PANEL ONLY AVAILABLE WITH ONE MINOR RIB)</small>	18, 24	■	■	■	■	■	■	■	■	■	■

MAXIMA 2" & 3" CAN BE FACTORY NOTCHED AT EITHER THE LAP END OR THE EAVE END, BUT NOT BOTH ENDS OF THE PANEL.
 MAXIMA ADV 2" IS ALSO AVAILABLE WITHOUT SHOULDERS.

MAXIMA

Maxima Seaming Details

Maxima
Before
Mechanical
Seaming

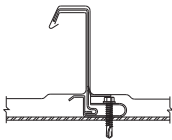

Maxima
90° Fold

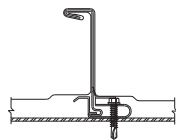

Maxima 1.5
Before
Mechanical
Seaming

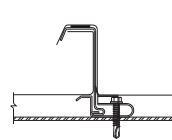

Maxima 1.5
180° Fold

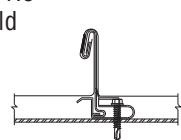

Maxima ADV
Before
Mechanical
Seaming

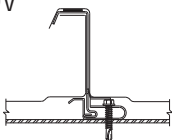

Maxima ADV
180° Fold

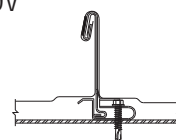

Maxima ADV
Without
Shoulders
Before
Mechanical
Seaming

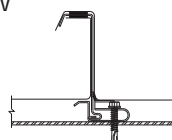

Maxima ADV
Without
Shoulders
180° Fold

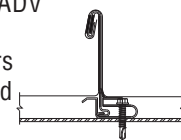

Details:

- Mechanically seamed profile
- Factory applied sealant (on non-curved panels only)
- Factory formed eave notch upon request
- Minimum slope: 1:12 for 1.5"
- Minimum slope: 1/2:12 for 2"
- Minimum slope: 1/4:12 for 3"
- Can be installed over solid deck or open framing
- Maxima 2" and ADV also available jobsite formed for long lengths
- Floating clips allow for 3 1/8" thermal movement

- Oil canning is a natural occurrence in metal panels and is not a cause for panel rejection.

Panel Options:

- Seam height: 1.5", 2" & 3"
- Maxima: 90 degree seam
- Maxima 1.5 and ADV: 180 degree seam
- Panel width: 12", 16", 18", and 24"
- Panel configurations:
 - Maxima, Maxima 1.5 and ADV: flat, striated, pencil ribs, minor ribs (3" only)
 - Maxima 1.5 and ADV: curved
- Coating:
 - Kynar 500® (PVDF)
- Substrate:
 - Standard 24 GA Galvalume®
 - Optional 22 GA Galvalume®
 - Optional .032 and .040 aluminum
 - No testing available on aluminum
- Maxima aluminum is produced in Sunnyvale, TX

Notes:

- Customers can rent mechanical seaming equipment directly from Developmenta Industries (DI). DI is the only McElroy approved seamer supplier.
- Please contact a McElroy representative for specific pricing, lead times, special colors or gauges that may not be on a McElroy Metal color chart.
- Contents in this manual are subject to change without notice. To confirm this book is the most current copy, please visit McElroy's website at www.mcelroymetal.com.

MAXIMA 1.5"

COMMERCIAL / INDUSTRIAL APPLICATIONS

TRIM 1.5" Maxima

Most Trims are 24 GA

Eave Trim*
Up to 4:12 Pitch
MLSE

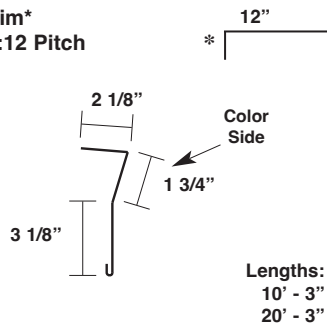

Sculptured Eave Trim
MLSCE

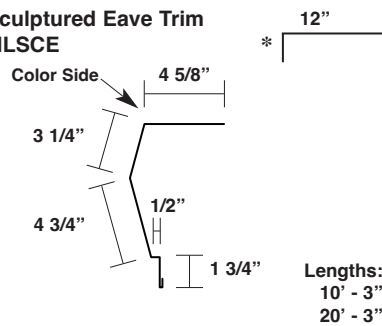

Valley Trim*
Up to 4:12 Pitch
MXVF

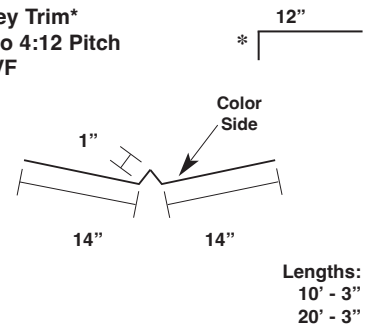

Rake Trim
MXRT

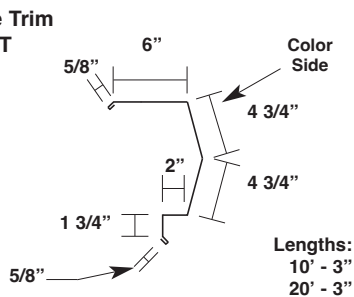

Rake Tie-In Trim
MXEW

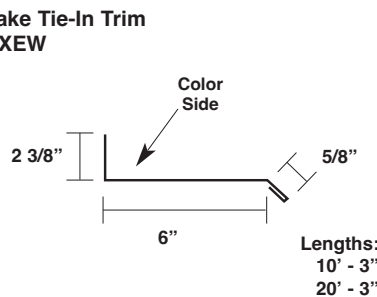

Rake Slide
MLRS

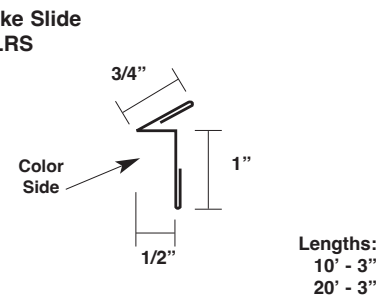

Rake End Cap
ML-RE

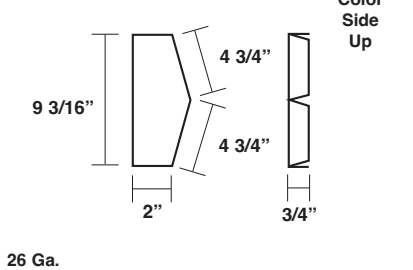

1.5" Zee Flashing
MX1ZF

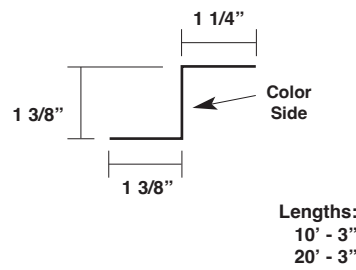

High Side Eave Trim*
Up to 2:12 Pitch
MLHS1

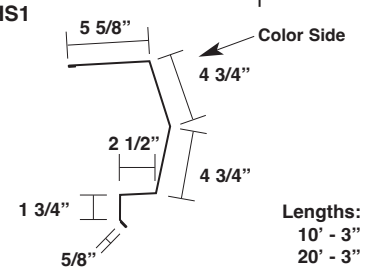

High Side Eave Trim*
Over 2:12 to 4:12 Pitch
MLHS4

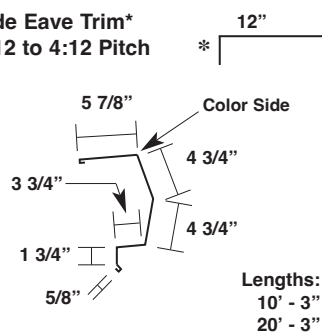

Fixed High Side Tie-In*
Up to 4:12 Pitch
MXSW

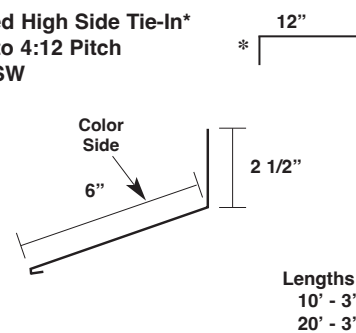

Floating High Side Tie-In*
Up to 4:12 Pitch
MXFSW

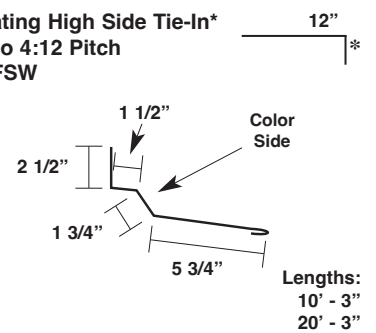

Hip Flashing*
Up to 4:12 Pitch
MXHF

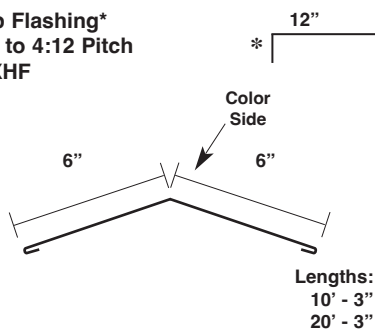

Floating Hip Trim*
Up to 4:12 Pitch
MXHFH

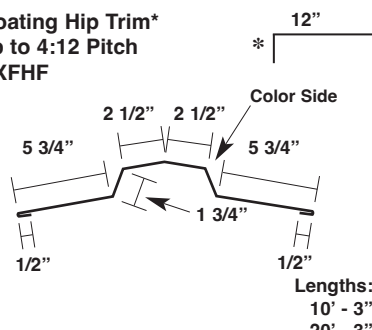

Fixed Ridge Trim*
Up to 4:12 Pitch
MFXR1

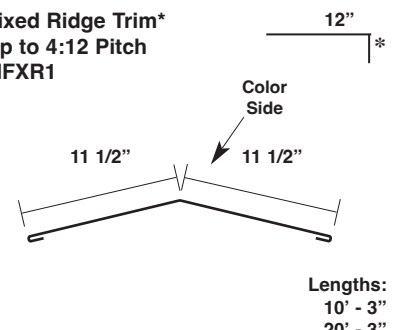

*specify roof pitch

(H) Indicates an open hem - All other hems are closed.

MAXIMA 1.5"

COMMERCIAL / INDUSTRIAL APPLICATIONS

TRIM 1.5" MAXIMA

Most Trims are 24 GA

Floating Ridge Trim*
Up to 4:12 Pitch
MFLR1

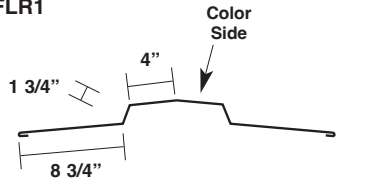

Lengths:
10' - 3"
20' - 3"

Fixed Peak Box
Up to 2:12 Pitch
MLFXPB2

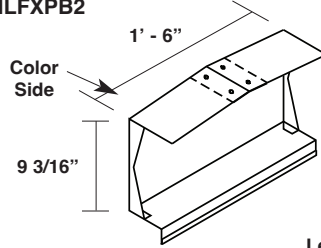

Lengths:
1' - 6"

Fixed Peak Box
Over 2:12 to 4:12 Pitch
MLFXPB4

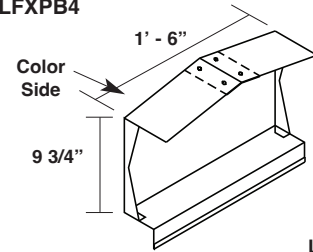

Lengths:
1' - 6"

Floating Peak Box
Up to 2:12 Pitch
MLFLPB2

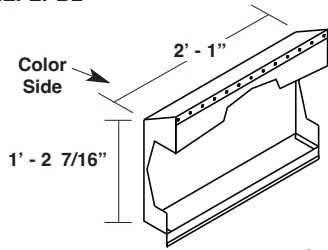

Lengths:
2' - 1"

Floating Peak Box
Over 2:12 to 4:12 Pitch
MLFLPB4

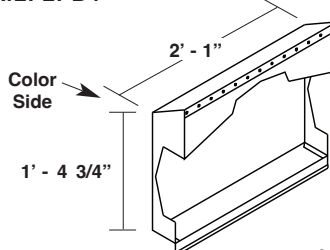

Lengths:
2' - 1"

Cinch Angle
ML-CA

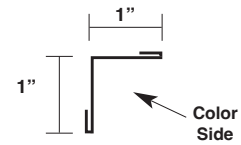

Lengths:
4"

26 Ga.

Gutter Corner Box for Sculptured Eave
Up to 4:12 Pitch
(Right Hand Shown Left Hand Opposite)
MLGCB

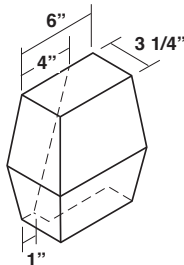

26 Ga.
(Right Hand Shown
Left Hand Opposite)

Hi-Side Corner Box
MLHCB

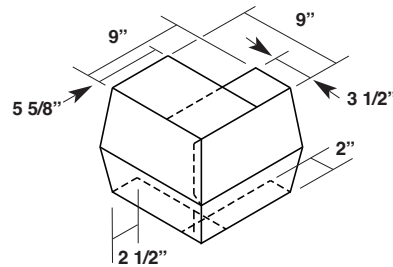

26 Ga.
(Right Hand Shown
Left Hand Opposite)

Outside Corner Box for Standard Gutter
Up to 2:12 Pitch
MLOCB

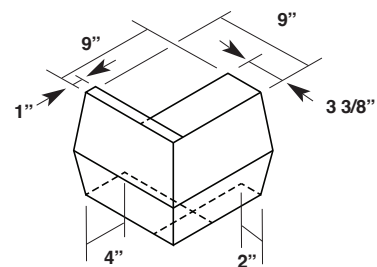

26 Ga.
(Right Hand Shown
Left Hand Opposite)

1.5" Maxima Gutter**
Up to 2:12 Pitch
MX1G2

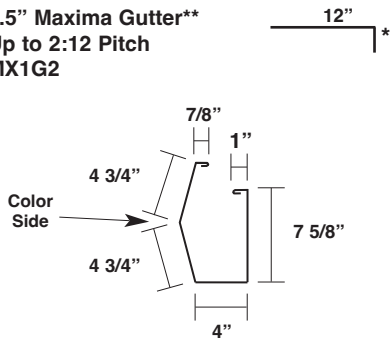

**Snow guards required to prevent damage caused by sliding snow.

Lengths:
10' - 3"
20' - 3"

Gutter Corner Box for Standard Gutter
2:12 to 4:12 pitch or with Sculptured Gutter
(Right Hand Shown-Left Hand Opposite)

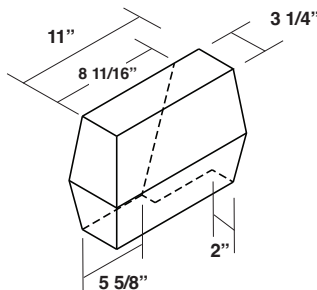

26 GA

Lengths:
N/A

1.5" Maxima Gutter**
Over 2:12 to 4:12 Pitch
MX2G4

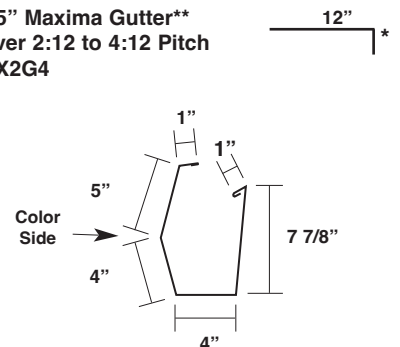

**Snow guards required to prevent damage caused by sliding snow.

Lengths:
10' - 3"
20' - 3"

MAXIMA 1.5"

COMMERCIAL / INDUSTRIAL APPLICATIONS

TRIM
1.5" Maxima

Most Trims are 24 GA

Gutter Strap
ML-GS

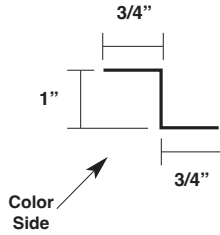

Lengths:
6"

Gutter End Cap
Up to 2:12 Pitch
MX2GEC2

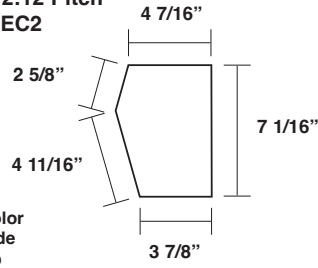

Color
Side
Up

26 Ga.

Downspout
BBPDS

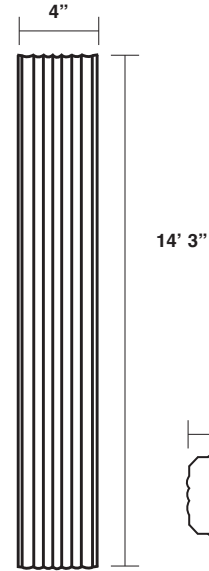

Lengths:
14'-3"

Gutter End Cap
Over 2:12 TO 4:12 Pitch
MX2GEC4

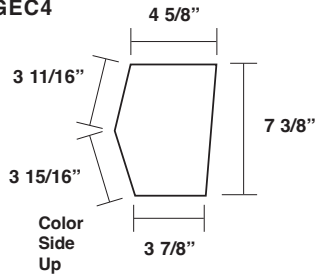

26 Ga.

Aluminum Downspout
Outlet Box
BBPOUT

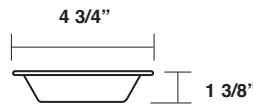

Only available in 26 Ga.

Downspout Strap
BBPDSS

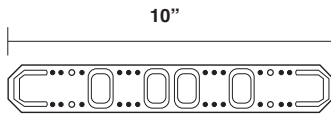

Only available in 26 Ga.

Lengths:
10"

3" x 4"
Downspout Elbow
A-Style
BBPELA

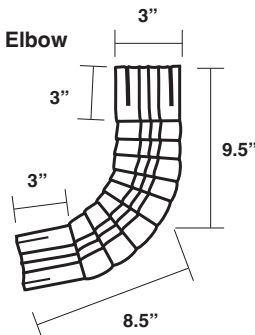

Only available in 26 Ga.

Lock-Seam Downspout - Corner
(Right Hand Corner Shown)

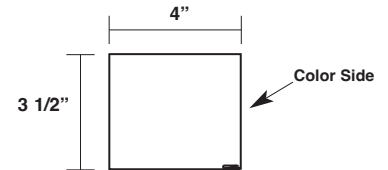

Please specify left or right hand corner

Lock-Seam Downspout - Center

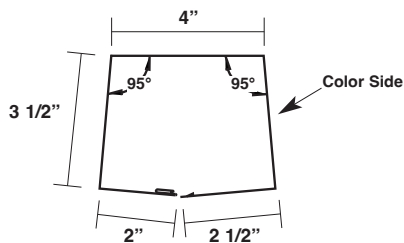

Lock-Seam Downspout Outlet -
Standard

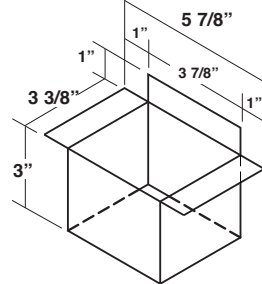

Lock-Seam Downspout Strap

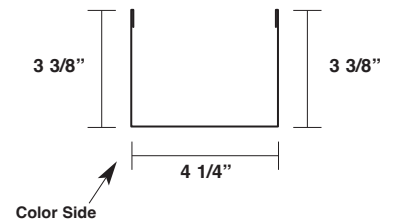

Notes:

MAXIMA 2" & ADV

COMMERCIAL / INDUSTRIAL APPLICATIONS

TRIM 2" & ADV

Most Trims are 24 GA

Eave Trim*
Up to 4:12 Pitch
MLSE

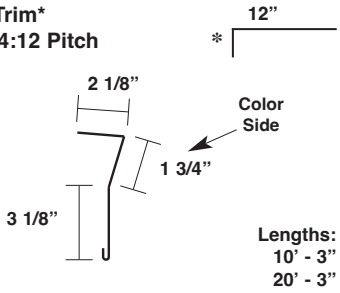

Sculptured Eave Trim*
Up to 4:12 pitch
MX2SCE4

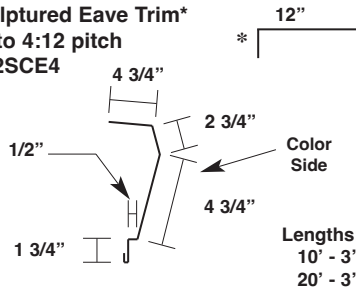

Valley Flashing*
Up to 4:12 Pitch
MXVF

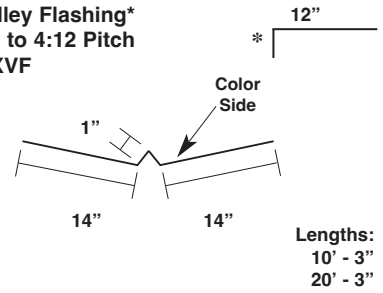

Rake Trim
MXRT

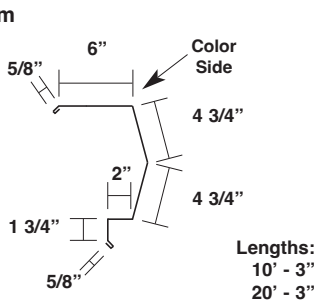

Rake Tie-In Trim
MXEW

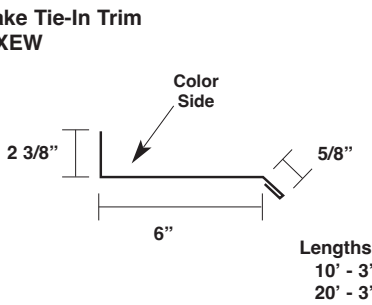

Rake Slide
MLRS

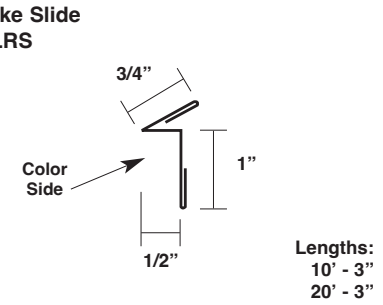

Rake End Cap
ML-RE

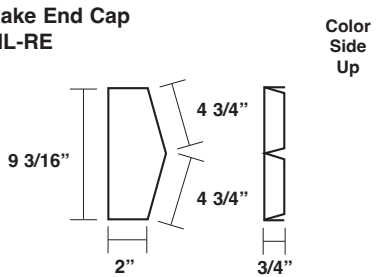

2" Zee Flashing
MX2ZF

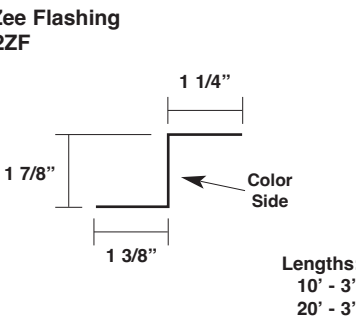

High Side Eave Trim*
Up to 2:12 Pitch
MLHS1

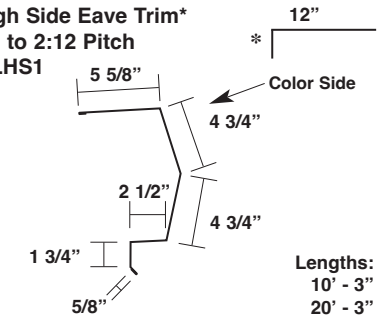

High Side Eave Trim*
Over 2:12 to 4:12 Pitch
MLHS4

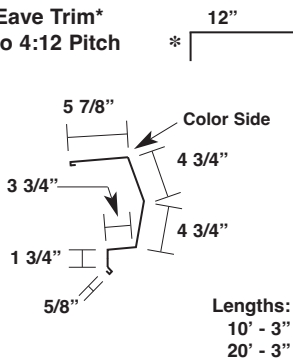

Fixed High Side Tie-In*
Up to 4:12 Pitch
MXSW

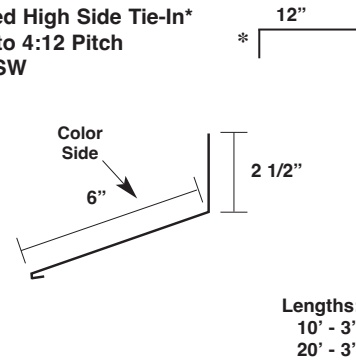

Floating High Side Tie-In*
Up to 4:12 Pitch
MXFSW

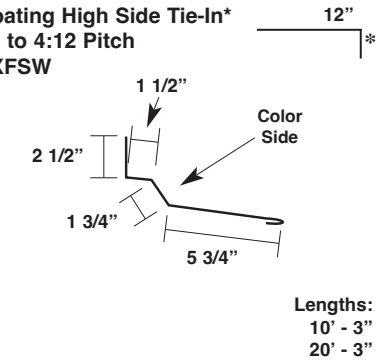

Hip Trim*
Up to 4:12 Pitch
MXHF

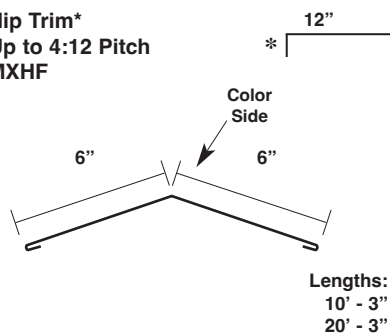

Floating Hip Trim*
MXHFH

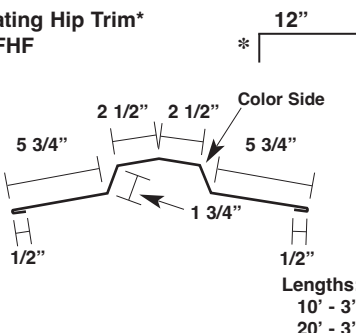

Fixed Ridge Trim*
Up to 4:12 Pitch
MFXR1

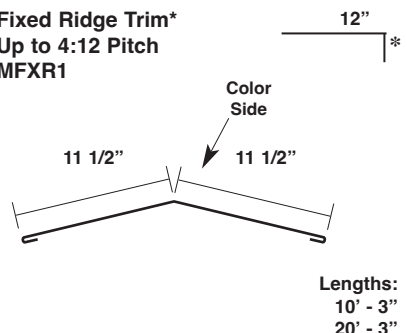

MAXIMA 2" & ADV

COMMERCIAL / INDUSTRIAL APPLICATIONS

TRIM
2" & ADV

Most Trims are 24 GA

Floating Ridge Trim*
Up to 4:12 Pitch
MFLR1

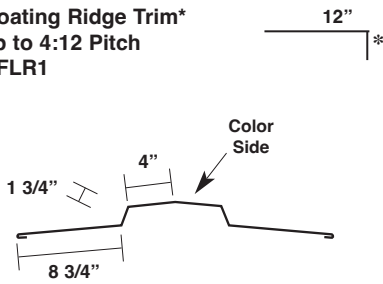

Lengths:
10' - 3"
20' - 3"

Fixed Peak Box
Up to 2:12 Pitch
MLFXPB2

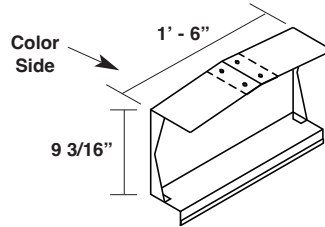

Lengths:
1' - 6"

Fixed Peak Box
Over 2:12 to 4:12 Pitch
MLFXPB4

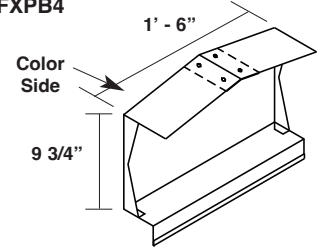

Lengths:
1' - 6"

Floating Peak Box
Up to 2:12 Pitch
MLFLPB2

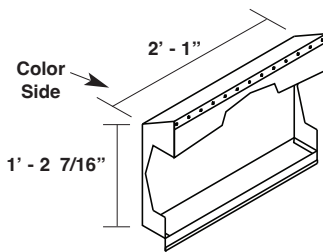

Lengths:
2' - 1"

Floating Peak Box
Over 2:12 to 4:12 Pitch
MLFLPB4

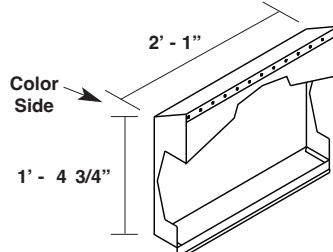

Lengths:
2' - 1"

Cinch Angle
ML-CA

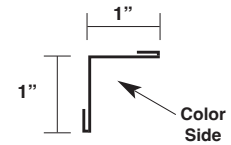

Lengths:
4"

Gutter Corner Box for Sculptured Eave
Up to 4:12 Pitch
MLGCB

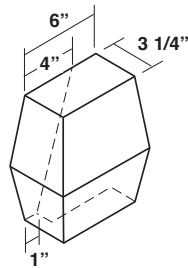

26 Ga.
(Right Hand Shown
Left Hand Opposite)

Hi-Side Corner Box
MLHCB

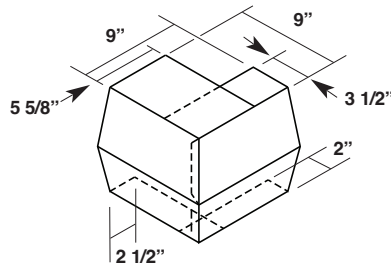

26 Ga.
(Right Hand Shown
Left Hand Opposite)

Outside Corner Box for Standard Gutter**
Up to 2:12 Pitch
MLOCB2

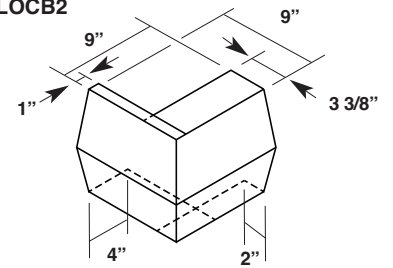

26 Ga.
(Right Hand Shown
Left Hand Opposite)

2" Maxima Gutter**
Up to 2:12 Pitch
MX2G2

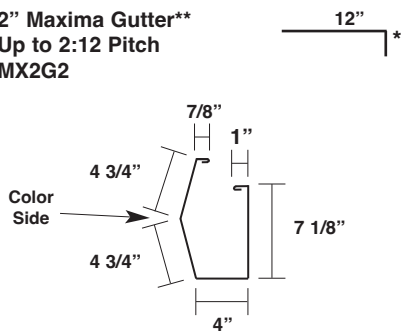

**Snow guards required to prevent damage caused by sliding snow.

Lengths:
10' - 3"
20' - 3"

Gutter Corner Box for Standard Gutter
2:12 to 4:12 pitch or with Sculptured Gutter
(Right Hand Shown-Left Hand Opposite)

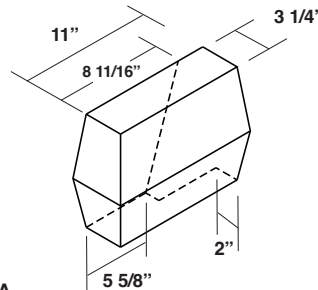

26 GA
(Right Hand Shown
Left Hand Opposite)

Lengths:
N/A

2" Maxima Gutter**
Over 2:12 to 4:12 Pitch
MX2G4

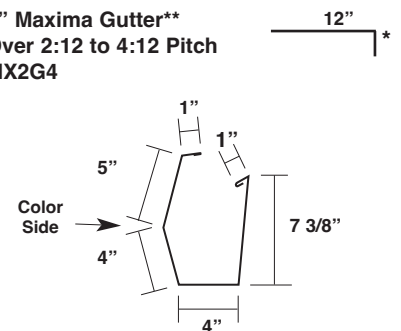

**Snow guards required to prevent damage caused by sliding snow.

Lengths:
10' - 3"
20' - 3"

*specify roof pitch

(H) Indicates an open hem - All other hems are closed.

MAXIMA 2" & ADV

TRIM
2" & ADV

COMMERCIAL / INDUSTRIAL APPLICATIONS

Most Trims are 24 GA

Gutter Strap
ML-GS

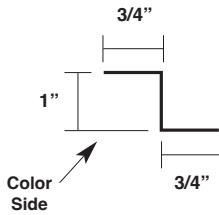

Lengths:
6"

Gutter End Cap - 2" Maxima
Up to 2:12 Pitch
MX2GEC2

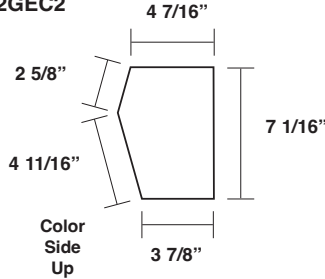

26 Ga.

Downspout
BBPDS

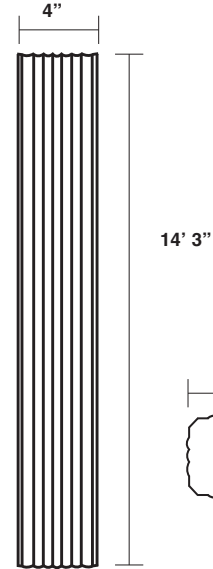

Lengths:
14'-3"

Gutter End Cap
Over 2:12 TO 4:12 Pitch
MX2GEC4

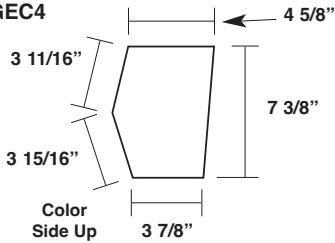

26 Ga.

Aluminum Downspout
Outlet Box
BBPOUT

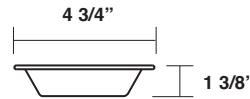

Only available in 26 Ga.

Downspout Strap
BBPDSS

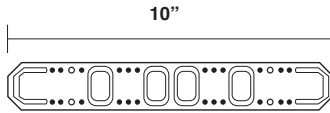

Only available in 26 Ga.

Lengths:
10"

3" x 4"
Downspout Elbow
A-Style
BBPELA

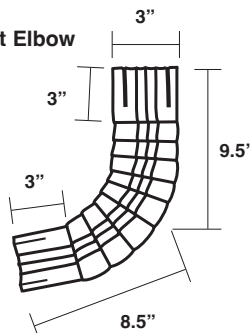

Only available in 26 Ga.

Lock-Seam Downspout - Corner
(Right Hand Corner Shown)

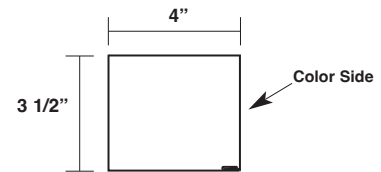

Please specify left or right hand corner

Lock-Seam Downspout - Center

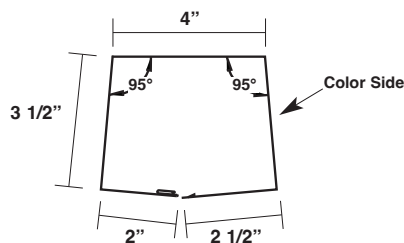

Lock-Seam Downspout Outlet - Standard

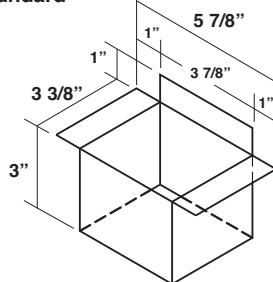

Lock-Seam Downspout Strap

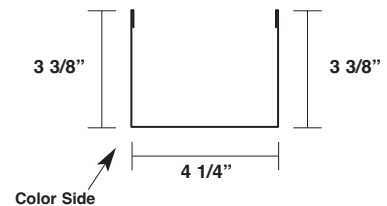

Notes:

MAXIMA 3"

COMMERCIAL / INDUSTRIAL APPLICATIONS

TRIM 3" Maxima

Most Trims are 24 GA

Eave Trim*
Up to 4:12 Pitch
MLSE

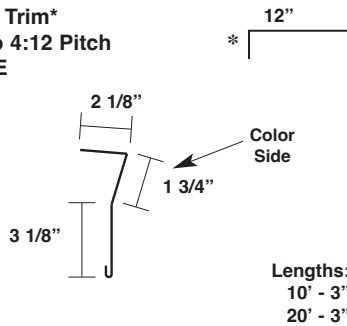

Sculptured Eave Trim*
Up to 4:12 pitch
MLSCE4

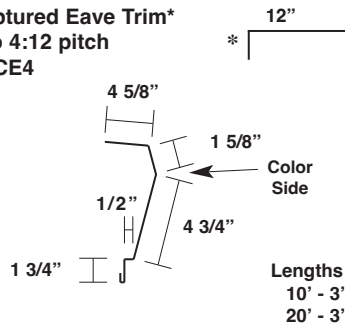

Valley Flashing*
Up to 4:12 Pitch
MXVF

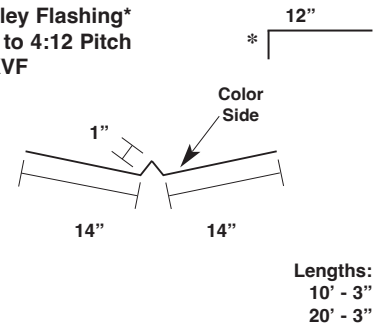

Rake Trim
MXRT

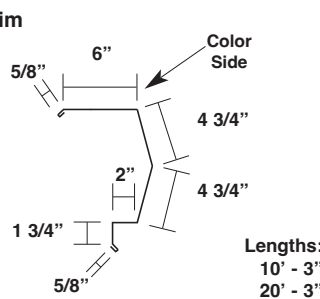

Rake Tie-In Trim
MXEW

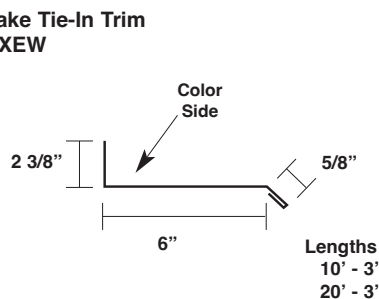

Rake Slide
MLRS

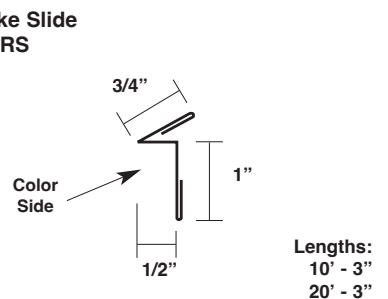

Rake End Cap
ML-RE

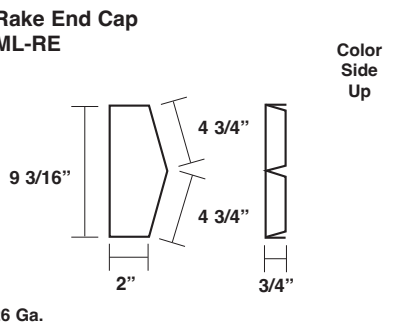

3" Zee Flashing
MX3ZF

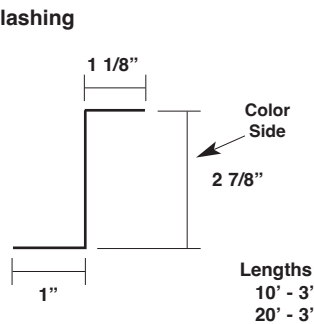

High Side Eave Trim*
Up to 2:12 Pitch
MLHS1

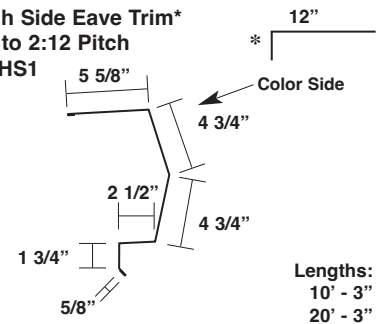

High Side Eave Trim*
Over 2:12 to 4:12 Pitch
MLHS4

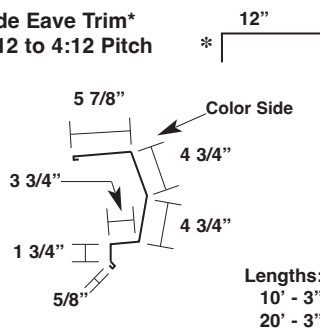

Fixed High Side Tie-In*
Up to 4:12 Pitch
MXSW

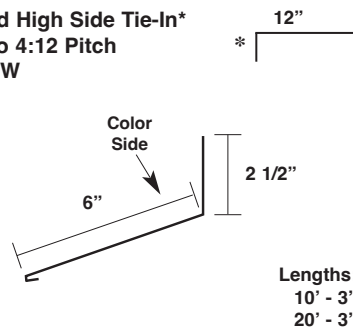

Floating High Side Tie-In*
Up to 4:12 Pitch
MXFSW

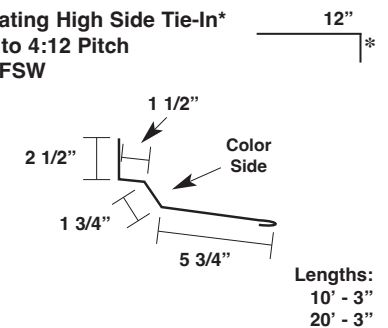

Hip Flashing*
Up to 4:12 Pitch
MXHF

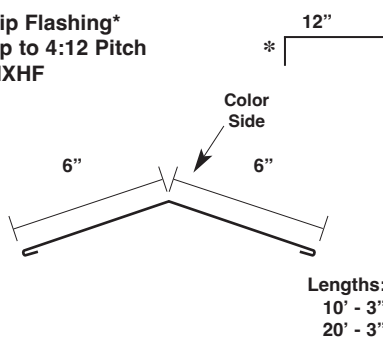

Floating Hip Flashing*
Up to 4:12 Pitch
MXHFH

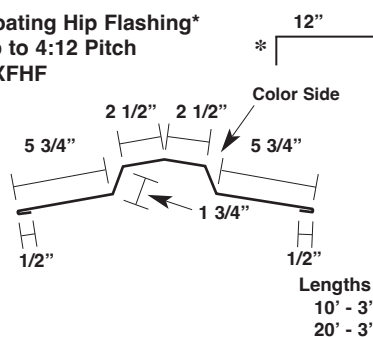

Fixed Ridge Flashing*
Up to 4:12 Pitch
MFXR1

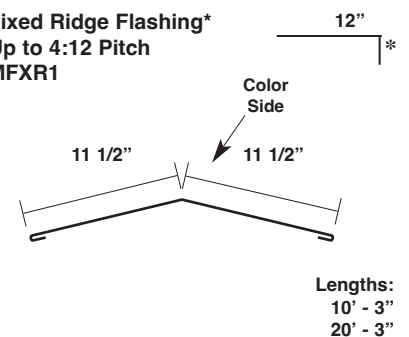

*specify roof pitch

(H) Indicates an open hem - All other hems are closed.

MAXIMA 3"

COMMERCIAL / INDUSTRIAL APPLICATIONS

TRIM 3" MAXIMA

Most Trims are 24 GA

Floating Ridge Flashing*
Up to 4:12 Pitch
MFLR1

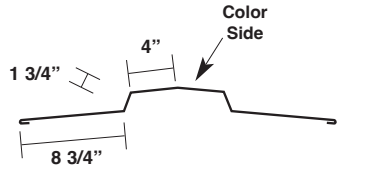

Lengths:
10' - 3"
20' - 3"

Fixed Peak Box
Up to 2:12 Pitch
MLFXPB2

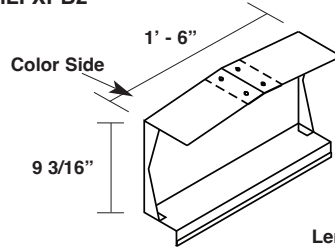

Lengths:
1' - 6"

Fixed Peak Box
Over 2:12 to 4:12 Pitch
MLFXPB4

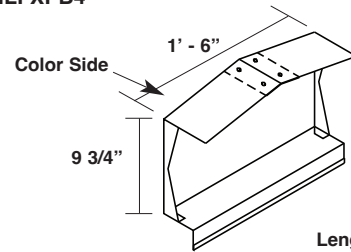

Lengths:
1' - 6"

Floating Peak Box
Up to 2:12 Pitch
MLFLPB2

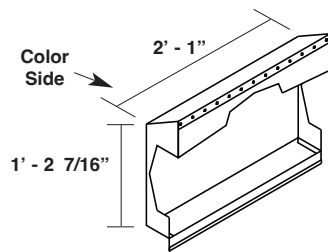

Lengths:
2' - 1"

Floating Peak Box
Over 2:12 to 4:12 Pitch
MLFLPB4

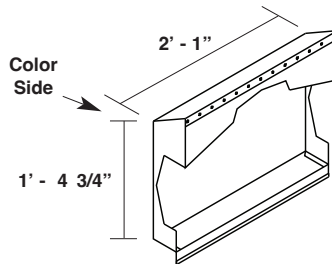

Lengths:
2' - 1"

Cinch Angle
ML-CA

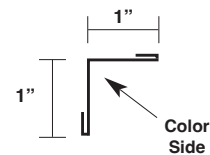

Lengths:
4"

Gutter Corner Box for Sculptured Eave
Up to 4:12 Pitch
MLGCB

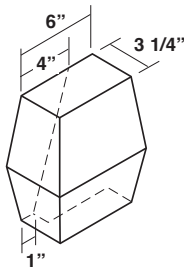

26 Ga.
(Right Hand Shown
Left Hand Opposite)

Hi-Side Corner Box
MLHCB

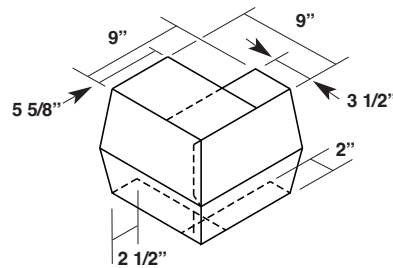

26 Ga.
(Right Hand Shown
Left Hand Opposite)

Outside Corner Box for Standard Gutter**
Up to 2:12 Pitch
MLOCB2

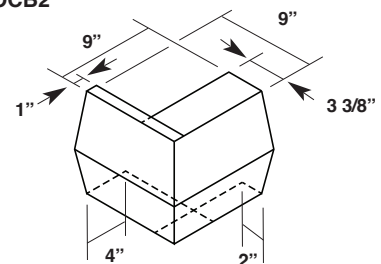

26 Ga.
(Right Hand Shown
Left Hand Opposite)

3" Maxima Gutter**
Up to 2:12 Pitch
MLG2

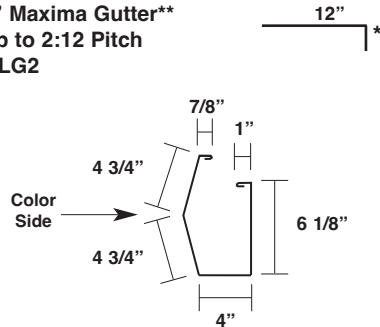

**Snow guards required to prevent damage caused by sliding snow.

Lengths:
10' - 3"
20' - 3"

Gutter Corner Box for Standard Gutter
2:12 to 4:12 pitch or with Sculptured Gutter
(Right Hand Shown-Left Hand Opposite)

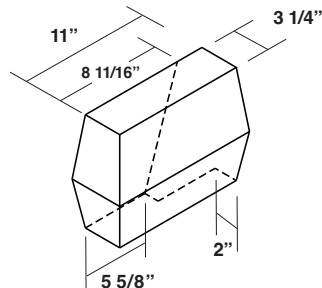

26 GA
(Right Hand Shown
Left Hand Opposite)

Lengths:
N/A

3" Maxima Gutter**
Over 2:12 to 4:12 Pitch
MLG4

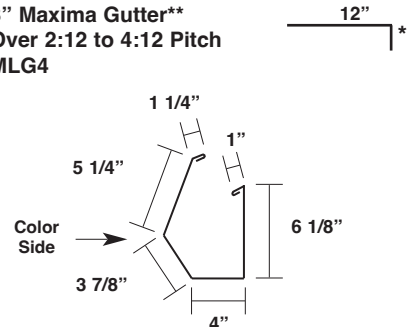

**Snow guards required to prevent damage caused by sliding snow.

Lengths:
10' - 3"
20' - 3"

MAXIMA 3"

TRIM
3" Maxima

COMMERCIAL / INDUSTRIAL APPLICATIONS

Most Trims are 24 GA

Gutter Strap
ML-GS

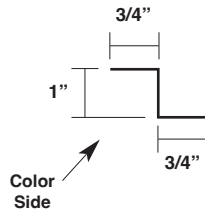

Lengths:
6"

Gutter End Cap
Up to 2:12 Pitch
MLGEC2

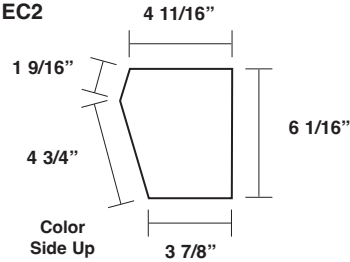

26 Ga.

Downspout
BBPDS

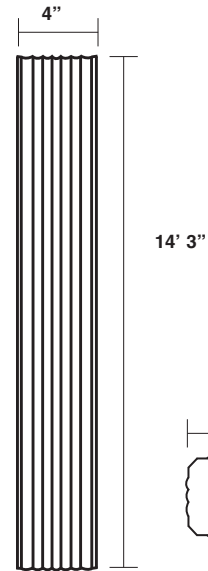

Lengths:
14'-3"

Gutter End Cap
Over 2:12 TO 4:12 Pitch
MLGEC4

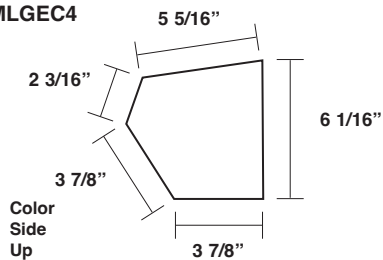

26 Ga.

Aluminum Downspout
Outlet Box
BBPOUT

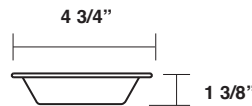

Only available in 26 Ga.

Downspout Strap
BBPDSS

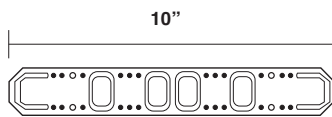

Only available in 26 Ga.

Lengths:
10"

3" x 4"
Downspout Elbow
A-Style
BBPELA

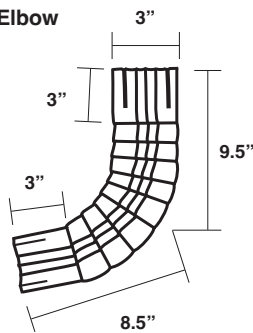

Only available in 26 Ga.

Lock-Seam Downspout - Corner
(Right Hand Corner Shown)

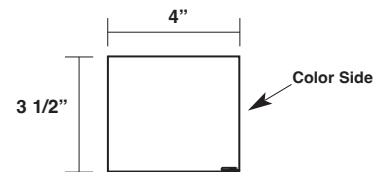

Please specify left or right hand corner

Lock-Seam Downspout - Center

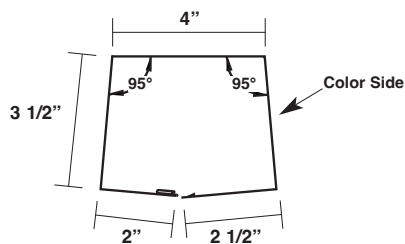

Lock-Seam Downspout Outlet - Standard

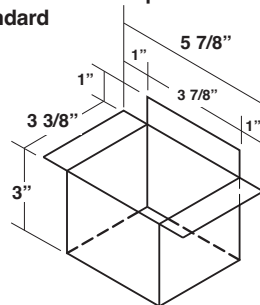

Lock-Seam Downspout Strap

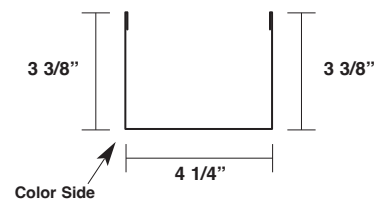

Notes:

*specify roof pitch

MAXIMA 1.5"

TRIM 1.5" Maxima

ARCHITECTURAL APPLICATIONS

Most Trims are 24 GA

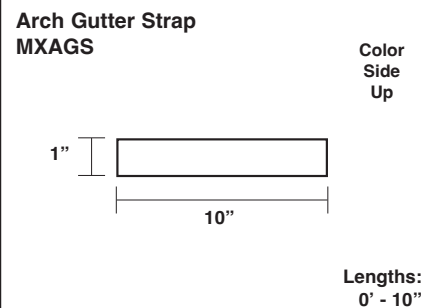
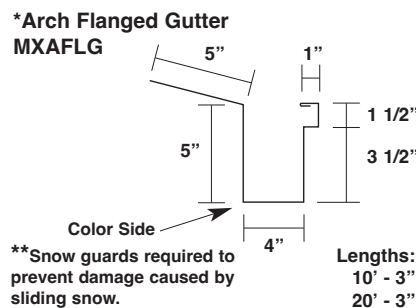
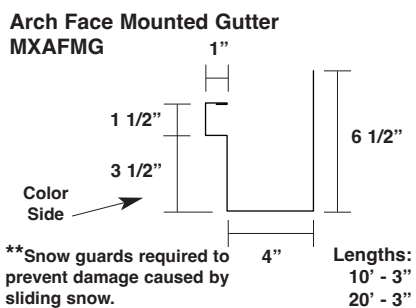
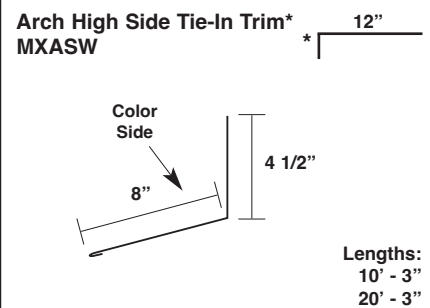
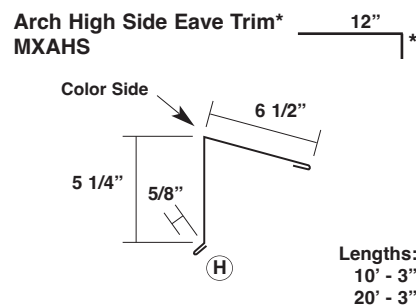
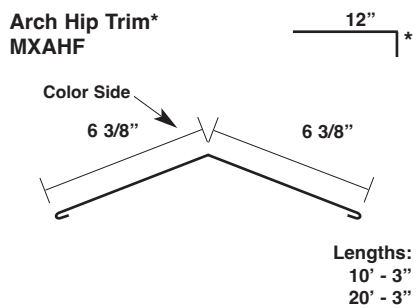
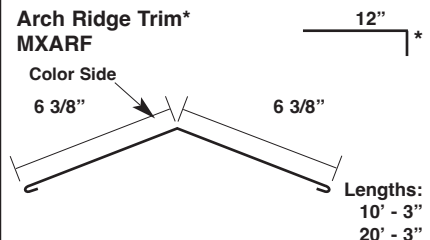
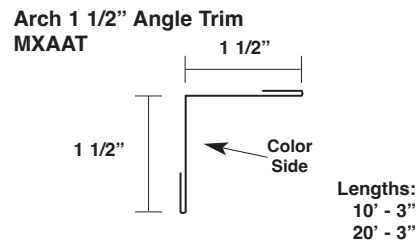
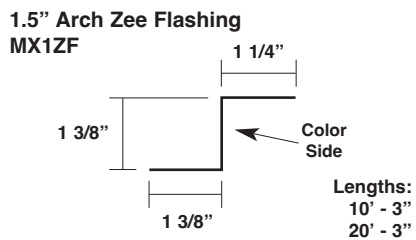
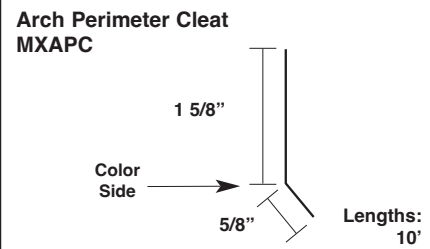
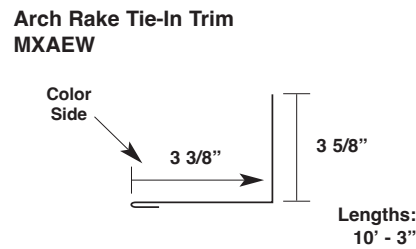
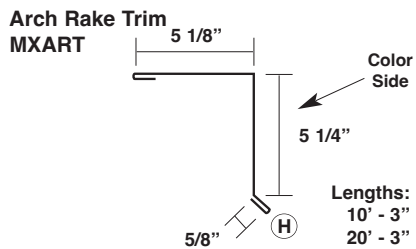
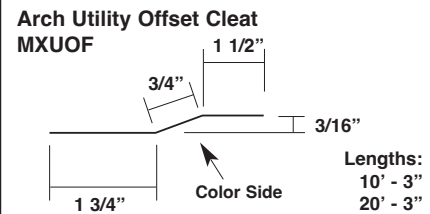
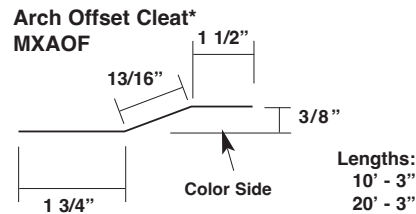
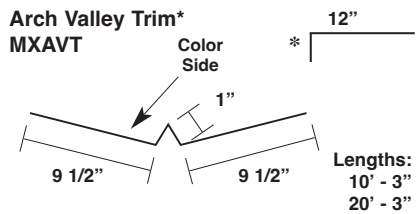
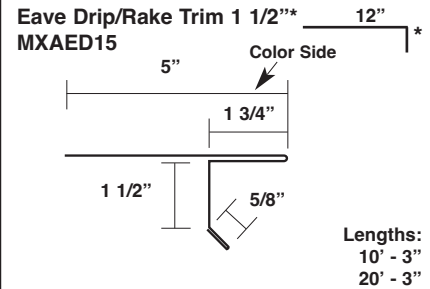
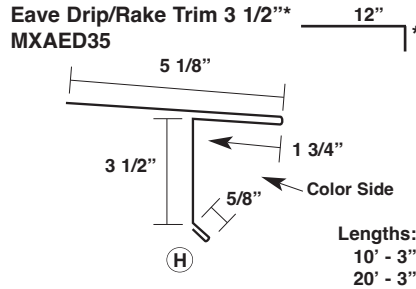
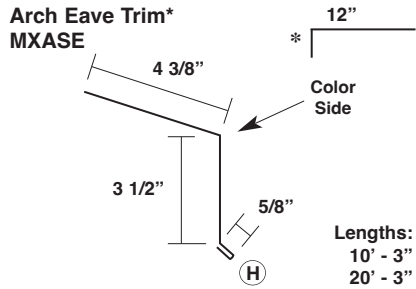

MAXIMA 1.5"

TRIM 1.5" Maxima

ARCHITECTURAL APPLICATIONS

<p>Arch Gutter End Cap MXAGEC</p> <p>Color Side Up</p> <p>Lengths: 10' - 3" 20' - 3"</p> <p>26 Ga. (Left Hand Shown Right Hand Opposite)</p>	<p>Aluminum Downspout Outlet Box BBPOUT</p>	<p>Downspout BBPPS</p> <p>Lengths: 14' - 3"</p> <p>Only available in 26 Ga.</p>
<p>Downspout Strap BBPDSS</p> <p>Lengths: 10"</p> <p>Only available in 26 Ga.</p>	<p>3" x 4" Downspout Elbow A-Style BBPELA</p> <p>Only available in 26 Ga.</p>	

MAXIMA 2" & ADV

TRIM 2" & ADV

ARCHITECTURAL APPLICATIONS

Most Trims are 24 GA

<p>Arch Eave Trim* MXASE</p> <p>Color Side</p> <p>Lengths: 10' - 3" 20' - 3"</p>	<p>Eave Drip/Rake Trim 3 1/2"* MXAED35</p> <p>Color Side</p> <p>Lengths: 10' - 3" 20' - 3"</p>	<p>Eave Drip/Rake Trim 1 1/2"* MXAED15</p> <p>Color Side</p> <p>Lengths: 10' - 3" 20' - 3"</p>
<p>Arch Valley Trim* MXAVT</p> <p>Color Side</p> <p>Lengths: 10' - 3" 20' - 3"</p>	<p>Arch Offset Cleat MXAOF</p> <p>Color Side</p> <p>Lengths: 10' - 3" 20' - 3"</p>	<p>Arch Utility Offset Cleat MXUOF</p> <p>Color Side</p> <p>Lengths: 10' - 3" 20' - 3"</p>
<p>Arch Rake Trim MXART</p> <p>Color Side</p> <p>Lengths: 10' - 3" 20' - 3"</p>	<p>Arch Rake Tie-In Trim MXAEW</p> <p>Color Side</p> <p>Lengths: 10' - 3"</p>	<p>Arch Perimeter Cleat MXAPC</p> <p>Color Side</p> <p>Lengths: 10'</p>

MAXIMA 2" & ADV

TRIM 2" & ADV

ARCHITECTURAL APPLICATIONS

Most Trims are 24 GA

**2" Arch Zee Trim
MX2ZF**

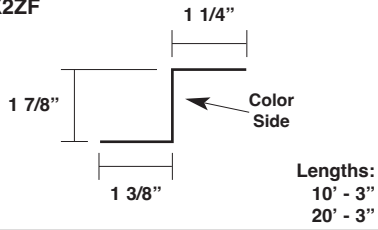

**Arch 1 1/2" Angle Trim
MXAAT**

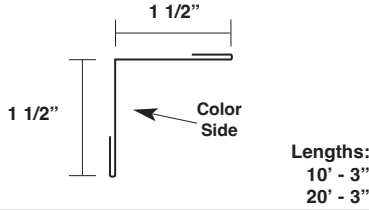

**Arch Ridge Trim*
MXARF**

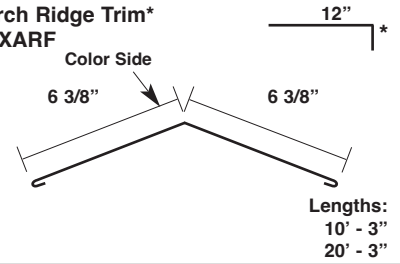

**Arch Hip Trim*
MXAHF**

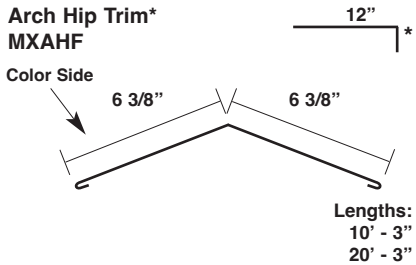

**Arch High Side Trim*
MXAHS**

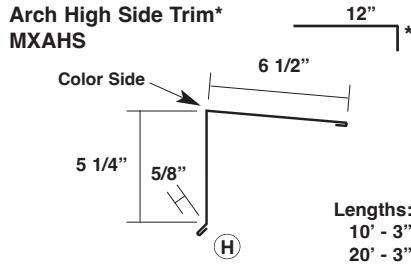

**Arch High Side Tie-In Trim*
MXASW**

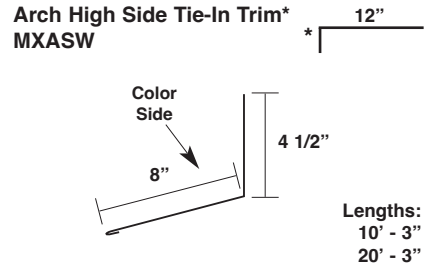

Ridge Flashing (Cor-A-Vent)

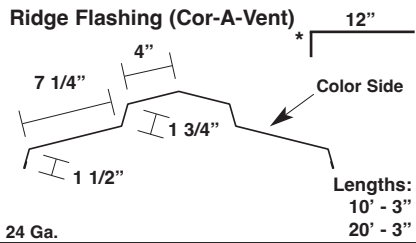

Spacer Trim (Cor-A-Vent)

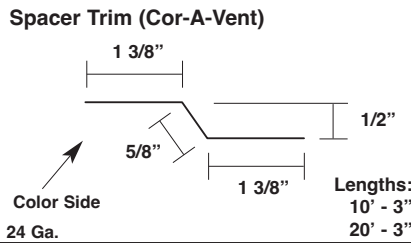

Diverter Trim (Cor-A-Vent)

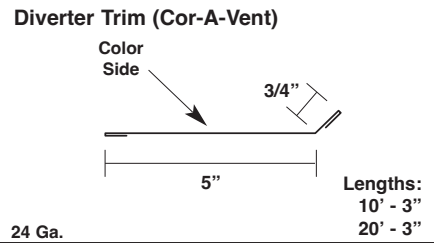

**Arch Face Mounted Gutter
MXAFMG**

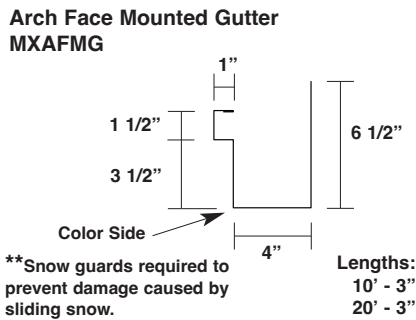

***Arch Flanged Gutter
MXAFLG**

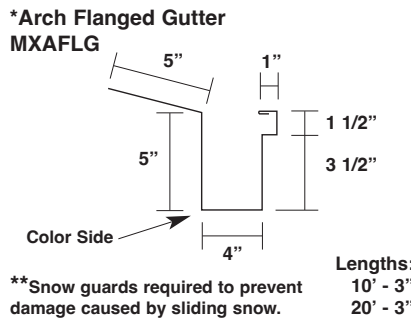

**Arch Gutter Strap
MXAGS**

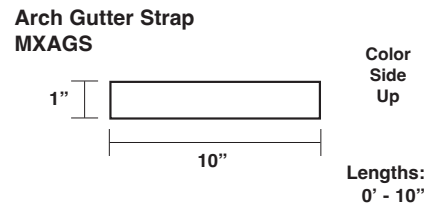

**Arch Gutter End Cap
MXAGEC**

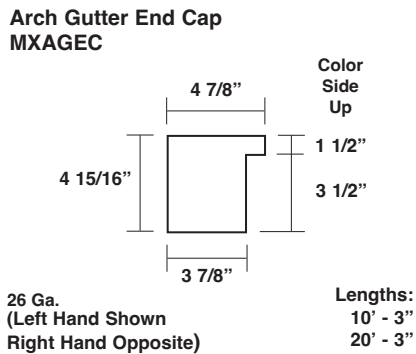

**3" x 4" Downspout Elbow
A-Style
BBPELA**

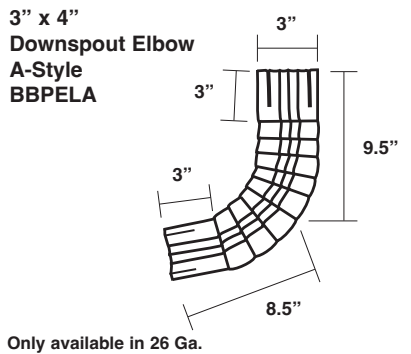

**Downspout
BBPPS**

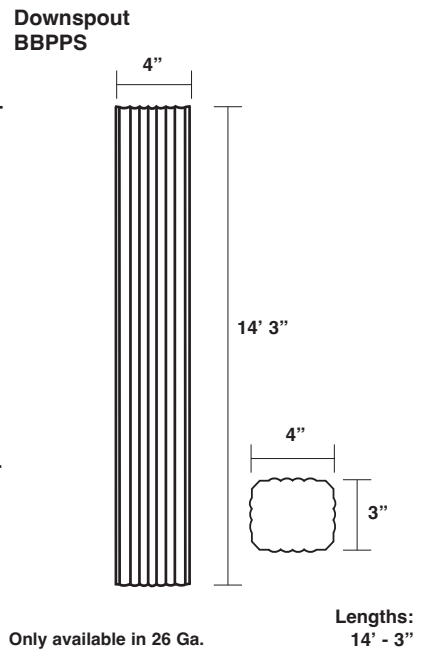

**Aluminum Downspout Outlet Box
BBPOUT**

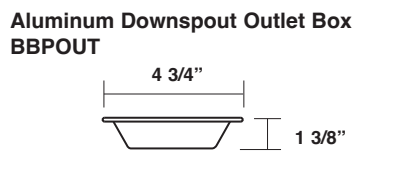

**Downspout Strap
BBPDSS**

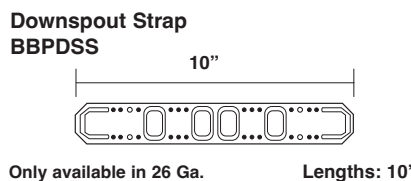

*specify roof pitch

(H) Indicates an open hem - All other hems are closed.

MAXIMA

ACCESSORIES

Maxima 1.5"
Low Floating Clip
Item #: 17434

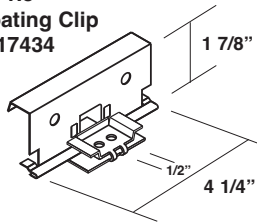

22 Ga.

2:16 and 2:18
Utility Fixed Clip
Item #: 17300

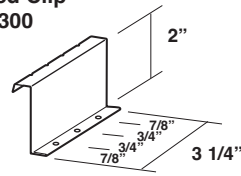

22 Ga.

2:16 and 2:18
Low Fixed Clip
Item #: 17302

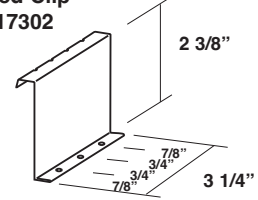

22 Ga.

2:16 and 2:18
High Fixed Clip
Item #: 17304

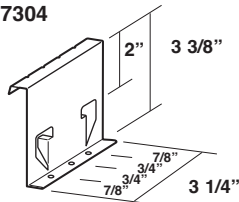

22 Ga.

2:16 and 2:18
Low Floating Clip
Item #: 17306

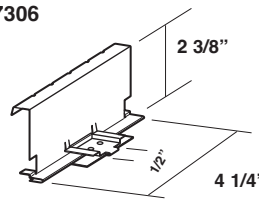

22 Ga.

2:16 and 2:18
High Floating Clip
Item #: 17308

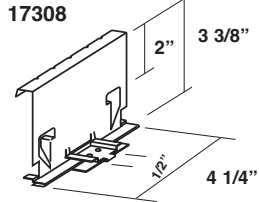

22 Ga.

3:24 Utility Fixed Clip
Item #: 17360

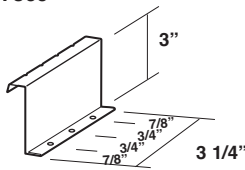

22 Ga.

3:24 Low Fixed Clip
Item #: 17362

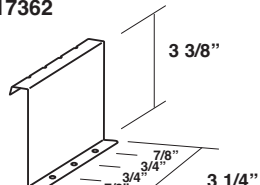

22 Ga.

3:24 High Fixed Clip
Item #: 17364

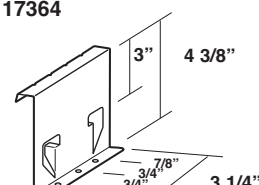

22 Ga.

3:24 Low Floating Clip
Item #: 17366

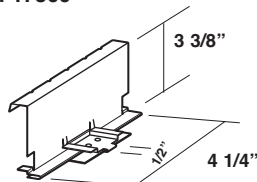

22 Ga.

3:24 High Floating Clip
Item #: 17368

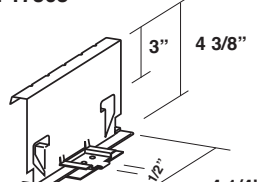

22 Ga.

Utility Eave Plate
Item #: 17477 Primed
Item #: 221025 Galvanized

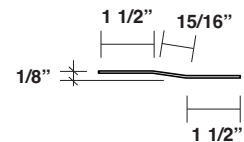

16 Ga.

Low Eave Plate
Item #: 10936 Primed
Item #: 224381 Galvanized

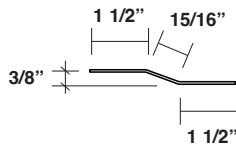

16 Ga.

High Eave Plate 14 GA
Item #: 17479 Primed

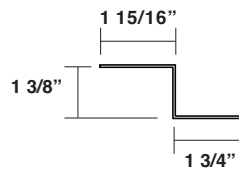

16 Ga.

High Eave Plate 16 GA
Item #: 10939 Primed
Item #: 204132 Galvanized

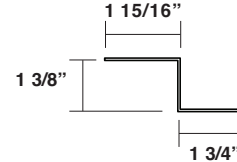

16 Ga.

Bearing Plate
Item #: 94599 Primed
Item #: 203541 Galvanized

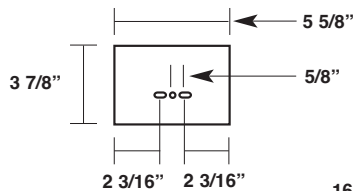

16 Ga.

Standard Back-Up Plate Galvanized
16" Item #: 17330
18" Item #: 17332
24" Item #: 17334

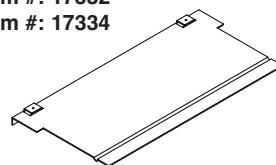

16 Ga.

High Floating Rake Plate
Item #: 17482

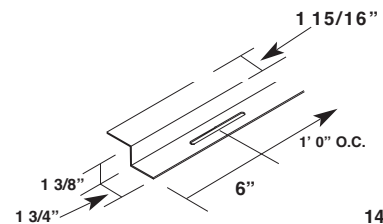

14 Ga.

MAXIMA

ACCESSORIES

Low Floating Eave Plate
Item #: 265013

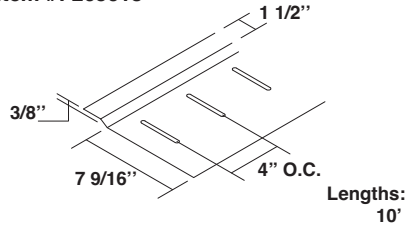

High Floating Eave Plate
Item #: 265014

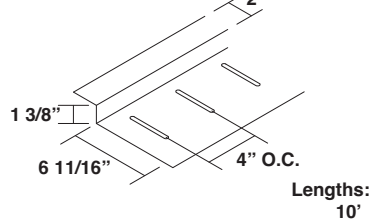

Low Floating Rake Plate 1 1/2" 15/16"
Item #: 17480

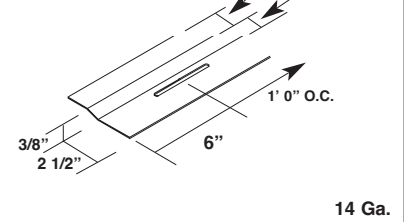

Maxima 1.5 Rake Support Angle
Primed Low Floating x 10'
Item #: 17527

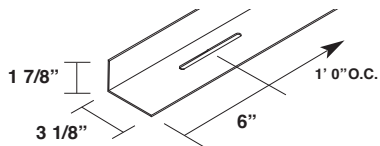

Maxima 2" / ADV Rake Support Angle
Primed Low Floating x 10'
Item #: 17530

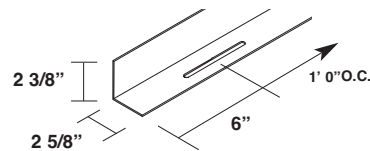

Maxima 2" / ADV Rake Support Angle
Primed High Floating x 10'
Item #: 17529

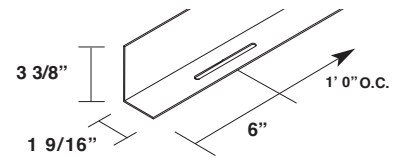

Maxima 3" Rake Support Angle
Primed High Floating x 10'
Item #: 17531

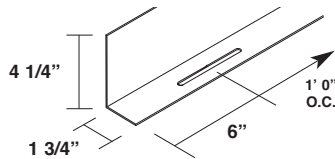

Maxima 2" Outside Universal Closure 16"
(Part # varies by color)

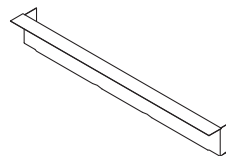

Maxima 2" Outside Universal Closure 18"
(Part # varies by color)

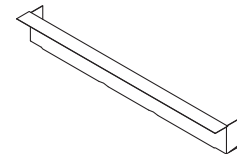

Maxima 3" Outside Closure 24"
(Part # varies by color)

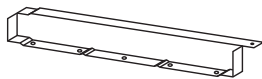

Cinch Strap 16"
(Part # varies by color)

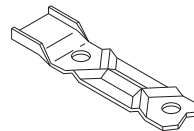

Cinch Strap 18"
(Part # varies by color)

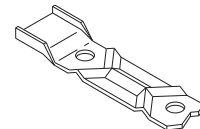

3:24 Cinch Strap 24"
(Part # varies by color)

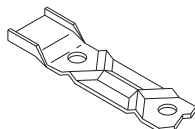

4' Back-Up Channel - Galvanized
Item #: 17400

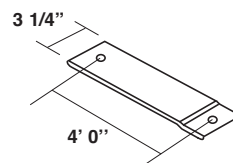

6' Back-Up Channel - Galvanized
Item #: 17402

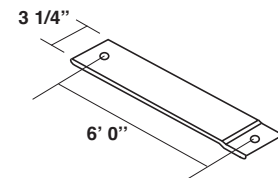

MAXIMA

ACCESSORIES

Thermal Spacer
 3/8" x 14 7/8" Item #: 17484
 3/8" x 16 7/8" Item #: 17488
 3/8" x 22 7/8" Item #: 17492

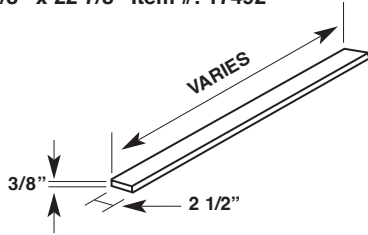

Thermal Spacer
 5/8" x 14 7/8" Item #: 17496
 5/8" x 16 7/8" Item #: 17497

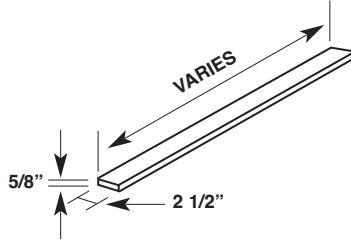

Thermal Spacer
 1" x 14 7/8" Item #: 17491
 1" x 16 7/8" Item #: 17486
 1" x 22 7/8" Item #: 17487

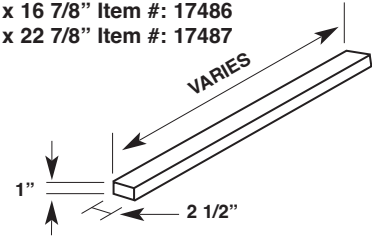

Thermal Spacer
 1 3/8" x 14 7/8" Item #: 17493
 1 3/8" x 16 7/8" Item #: 17494

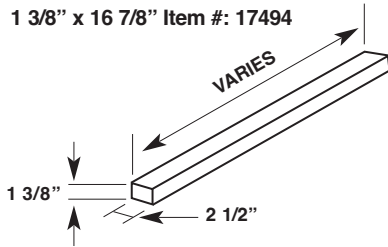

**1/4 - 14 x 1 1/4" TEK2
 Self Driller
 W/O Washer - Plain
 Item #: 10969**

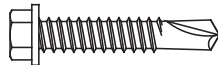

**#14 x 1 1/2"
 Type A
 Item #: 94015**

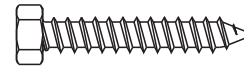

**#12 - 24 x 1 1/4"
 TEK 4.5
 W/O Washer - Plain
 Item #: 10979**

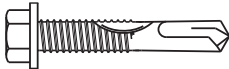

**1/4 - 14 x 1 1/4"
 Shoulder TEK2 3/8
 HWH W/O Washer - Plain
 Item #: 10975**

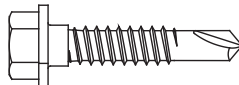

**1/4 - 14 x 1 1/4"
 TEK2 ZAC
 (Part # varies by color.)**



**1/4 - 14 x 7/8"
 LAPTEK ZAC
 Self Driller
 (Part # varies by color.)**

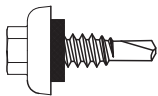

**#14 - 10 x 1 1/2"
 ZXL WOODBINDER
 (Part # varies by color)**

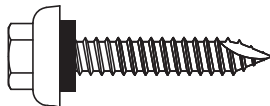

**43D Pop rivets
 (Part # varies by color)**

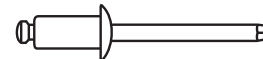

**#12 - 13 Dekfast Phillips
 (Length varies by application)**



**#10 - 16 x 1"
 TEK2 Pancake Head
 Self-Driller - Plain
 Item #: 36117**

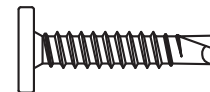

MAXIMA

ACCESSORIES

#10 - 12 x 1"
Type A Pancake Head
Woodgrip - Plain
Item #: 36116001

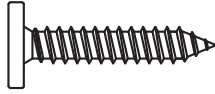

Touch-Up Paint Pen
(Part # Varies by Color)



Sikalastomer Butyl Sealant
Item #: 95342



Titebond Caulk Sealant
(Part # varies by color)



Butyl Double Bead Tape Sealant
3/16" x 7/8" x 40'
Item #: 95460

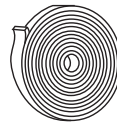

Butyl Tape Sealant
3/32" x 1" x 45'
Item #: 95335

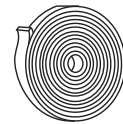

Butyl Tape Sealant
3/32" x 3/8" x 45'
Item #: 95340

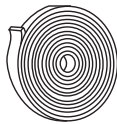

Strip Tape
3/4" x 1 3/8" x 4"
Item #: 95365
(Used with Maxima 324 Only)

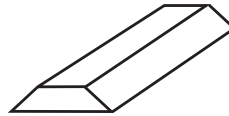



☆ MANUFACTURING LOCATIONS ● SERVICE CENTERS ★ MANUFACTURING AND SERVICE CENTER



CORPORATE OFFICE
 1500 HAMILTON RD.
 BOSSIER CITY, LA 71111

MANUFACTURING LOCATIONS

- | | | | | |
|--------------|--------------------|------------------|----------------|-------------|
| ADELANTO, CA | ASHBURN, GA | BOSSIER CITY, LA | CLINTON, IL | DIAMOND, MO |
| HOUSTON, TX | LEWISPORT, KY | LOCKHART, TX | MARSHALL, MI | MAUSTON, WI |
| MERKEL, TX | PEACHTREE CITY, GA | SUNNYVALE, TX | WINCHESTER, VA | |



17031 Koala Road Adelanto, CA 92301	5215 Leo St. Alexandria, LA 71301	1007 Wilso Dr, Baltimore, MD 21223	1500 Hamilton Rd. Bossier City, LA 71111
3052 Yadkin Road Chesapeake, VA 23323	9476 Meadowbrook Rd. Clinton, IL 61727	3215 Highway 59 Diamond, MO 64840	390 N. Valley Dell Dr. Fenton, MO 63026
409 Lovejoy Road Ft. Walton Beach, FL 32548	3014 Lincoln Court Garland, TX 75041	1440 Aldine Bender Road Houston, TX 77032	221 Benelli Drive Hutto, TX 78634
10504 E. 59th Street Indianapolis, IN 46236	32 Industrial Circle Lancaster, PA 17601	9435 US Hwy. 60 W. Lewisport, KY 42351	2701 Cahill Street Lockhart, TX 78644
1020 Veterans Street Mauston, WI 53948	5123 Terminal Dr. McFarland, WI 53558	514 Cave Road Nashville, TN 37210	8304 Hwy. 70 E. North Little Rock, AR 72117
613 North Bierdeman Rd. Pearl, MS 39208	8511 Industrial Drive Pearland, TX 77584	2755 Hwy 60 Pendergrass, GA 30567	7450 Tower Street Richland Hills, TX 76118
8200 Berry Ave. Suite 100 Sacramento, CA 95828	1365 Dean Forest Rd. Savannah, GA 31405	7355 Oakley Industrial Blvd. Union City, GA 30291	1144 Silstar Rd. West Columbia, SC 29170
325 McGhee Rd. Winchester, VA 22603			

Website: www.mcelroymetal.com • E-mail: info@mcelroymetal.com