

SLOPES LESS THAN 3:12 WILL REQUIRE THE PAN OF THE PANEL TO BE FOLDED UP.

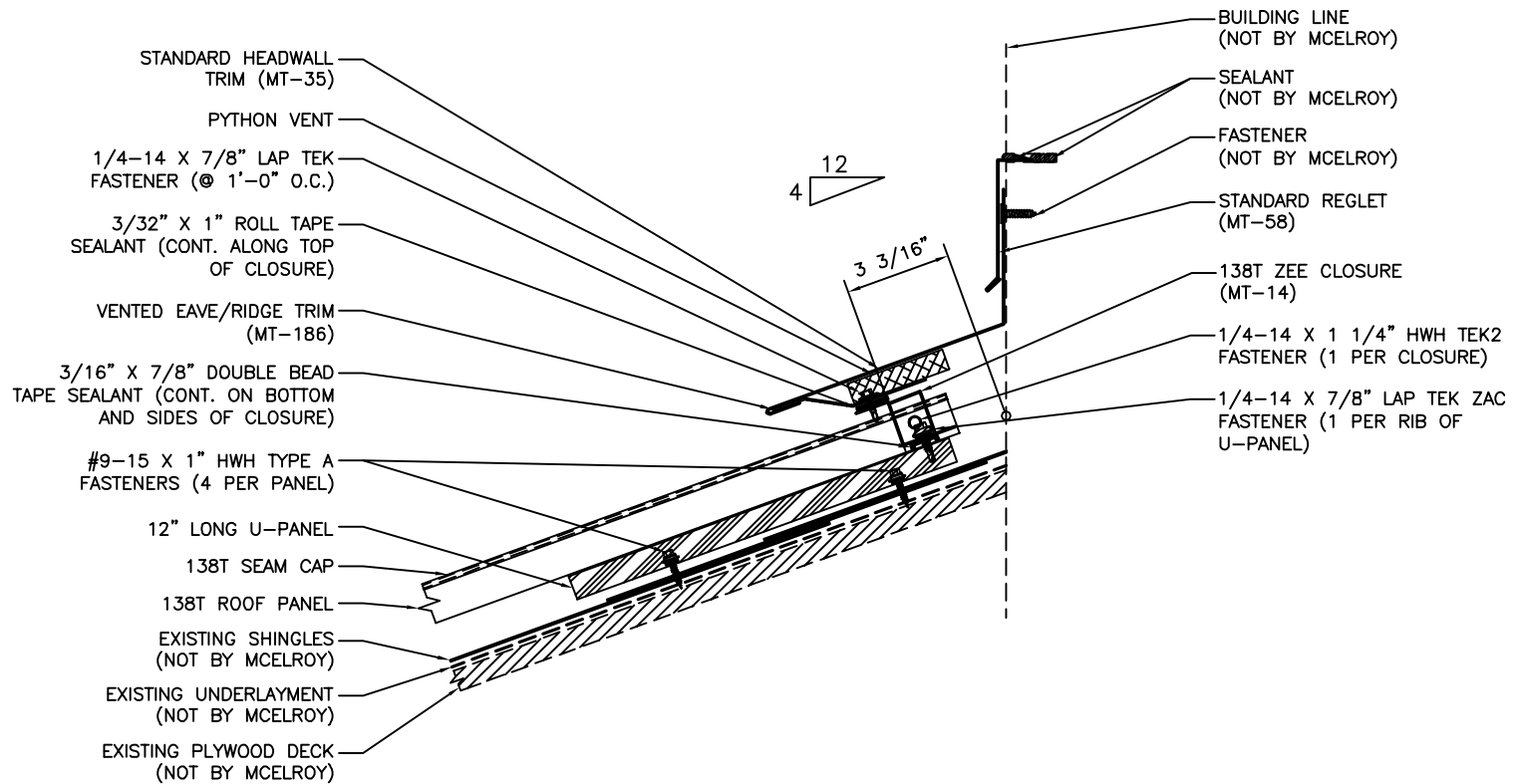

HIGH SIDE TIE-IN DETAIL

ISSUE/REVISION DATE:

03/10/2016

ROOF PANEL: 138T

SUBSTRATE: SHINGLE DECKED

SCALE: N.T.S.