

SLOPES LESS THAN 3:12 WILL
REQUIRE THE PAN OF THE
PANEL TO BE FOLDED UP.

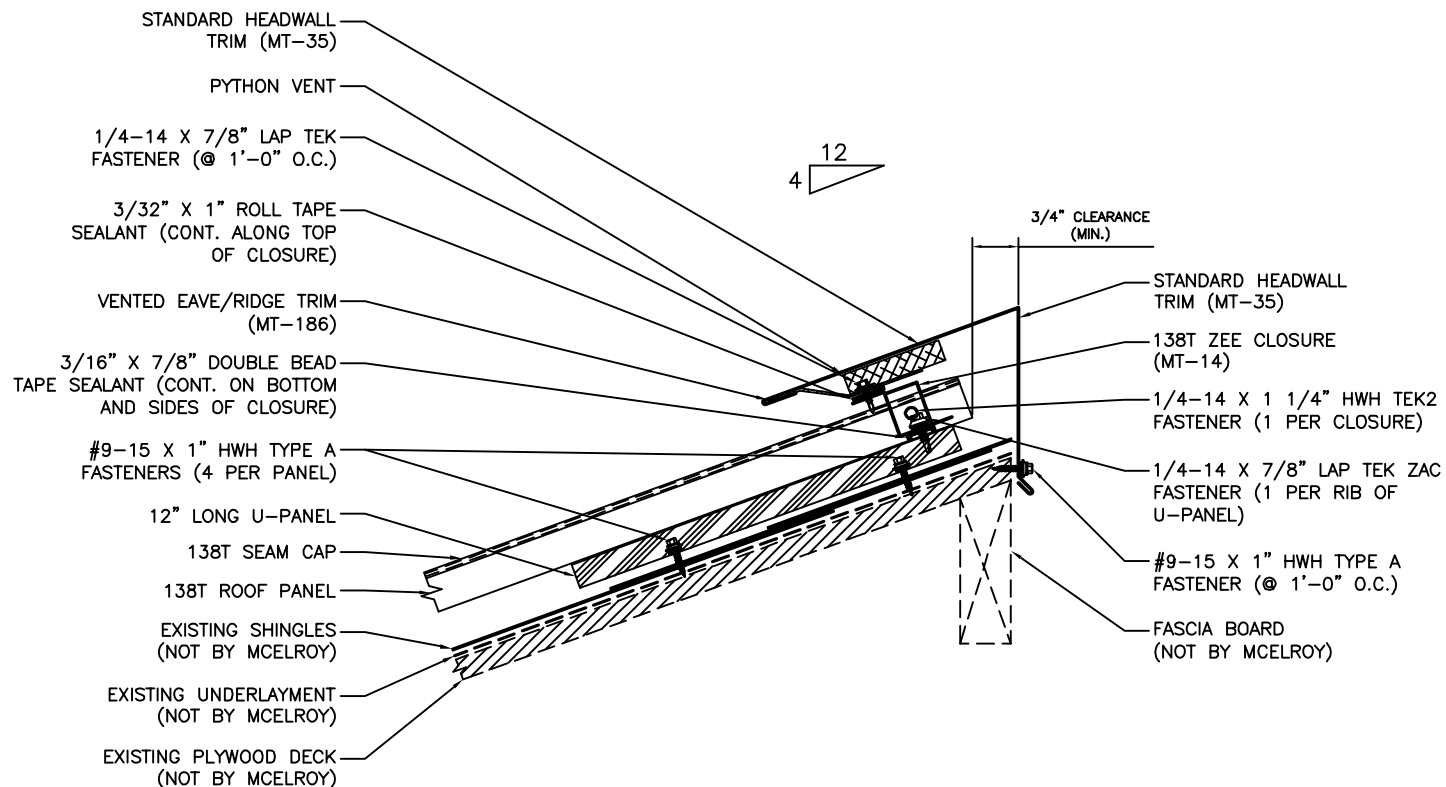

HIGH EAVE DETAIL

ISSUE/REVISION DATE:

03/10/2016

ROOF PANEL: 138T

SUBSTRATE: SHINGLE DECKED

SCALE: N.T.S.